



# PICKWORTH

Balanced Flue Stove  
**2306**

**Fuel Effect Gas Fire**

**Gas Options:**  
NG Only

**Control Options:**  
Manual  
Or  
Total Remote Control

For use only on Natural Gas (G20) at a supply pressure of 20mbar in GB and IE.

**Please check all gas connections on burner tray as they can work loose in transit.**

**User Instructions.  
Installation & Servicing  
Instructions.**

**MUST BE LEFT WITH THE END USER**

**Manufacturer Contact Details:**

Burley Appliances Ltd  
Lands' End Way  
Oakham  
Rutland LE15 6RB

Tel: +44 (0)1572 725570  
Fax: +44 (0)1572 724390

General E-Mail: info@burley.co.uk  
Web Site: www.burley.co.uk  
Technical Support: Direct Dial on (01572 725570) or email: info@burley.co.uk

**Burley Magiglo Document Number:**  
MF2306.1

**Revision Date:**  
16 AUGUST 2017 CAS

**Copyright:**  
This documentation is copyrighted by Burley Appliances Ltd. ©2017.  
No part of this document may be copied, photocopied or reproduced in any form or by any means without permission in writing from Burley Appliances Ltd.

**Service Warranty:**  
In the unlikely event of a defect in materials or workmanship occurring within one year of purchase, Burley will arrange to repair or replace the item free of charge.  
Any claims under this warranty must be made through the retailer from whom the product was purchased.  
As the purchaser's contract of sale is with the retailer, Burley are unable to enter into discussions with the purchaser until the retailer has inspected any claim and deemed it to be valid.  
Burley Appliances reserve the right to refuse service or make a charge for any service call, when a defect is due to installation error or misuse.  
Extended warranty (if purchased) commences after the first year; please see separate registration for further information.

**Appliance Details:**  
For future reference, please complete the following information at the time of installation.  
**Model** and **Serial Number** details may be found on the data plate as shown.

Serial Number	
Model	
Installation Date	
Installed By	

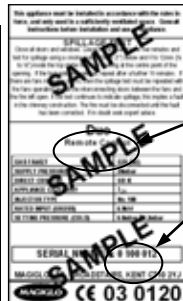

# Contents

<b>1.</b>	<b>GENERAL INFORMATION .....</b>	<b>4</b>
<b>2.</b>	<b>USER INSTRUCTIONS TO BE LEFT WITH CUSTOMER .....</b>	<b>6</b>
2.1.	<i>Location of Pilot Burner.....</i>	6
2.2.	<i>Lighting Procedure.....</i>	7
2.2.1.	<i>Lighting Procedure (Manual Control).....</i>	8
2.2.2.	<i>Lighting Procedure (Total Control) .....</i>	9
2.3.	<i>Battery Replacement (Remote Control).....</i>	10
2.3.1.	<i>Handset .....</i>	10
2.3.2.	<i>Receiver Unit .....</i>	10
2.4.	<i>Home Improvements.....</i>	11
2.5.	<i>Cleaning and Care Instructions .....</i>	12
2.5.1.	<i>Painted Metal Surfaces .....</i>	12
2.5.2.	<i>Glass Surfaces .....</i>	12
<b>3.</b>	<b>INSTALLATION INSTRUCTIONS FOR USE BY THE 'GAS SAFE' ENGINEER.....</b>	<b>13</b>
3.1	<i>General Safety Requirements .....</i>	13
3.2	<i>General Dimensions.....</i>	13
3.3	<i>Flue Options.....</i>	14
3.4	<i>Technical Data .....</i>	14
3.5	<i>Appliance Location.....</i>	15
3.5.1	<i>Clearances to Combustible &amp; Non Combustible Surfaces .....</i>	16
3.6	<i>Flue Terminal Location.....</i>	19
3.7	<i>Flue Components.....</i>	20
3.8	<i>Contents Checklist .....</i>	20
3.9	<i>Installation Procedure.....</i>	21
3.9.1	<i>Pre-Installation Procedure.....</i>	21
3.9.6	<i>Fuel Effects Layout .....</i>	26
3.9.7	<i>Coal Effect Layout.....</i>	27
3.9.8	<i>Fitting the Glass Panel and frame .....</i>	28
3.9.9	<i>Assembling Outer Casing.....</i>	28
3.9.10	<i>Commissioning .....</i>	29
3.9.11	<i>Instructing the User.....</i>	30
<b>4</b>	<b>SERVICING INSTRUCTIONS.....</b>	<b>31</b>
4.1	<i>General Requirements .....</i>	31
4.1.1	<i>Cleaning the Fuel Effect, Fire-bed and Combustion Chamber .....</i>	32
4.1.2	<i>Cleaning Lining Board Panels .....</i>	32
4.1.3	<i>Care of Lining Panels.....</i>	32
4.2	<i>Replacing Parts.....</i>	33
4.2.1	<i>Burner Components Removal and Replacement.....</i>	33
4.2.2	<i>Pilot Components Removal and Replacement .....</i>	33
4.2.3	<i>Injector Replacement .....</i>	34
4.2.4	<i>Control Valve Replacement (Manual Control /Total Remote Control) .....</i>	35
4.3	<i>Installation and Operational Troubleshooting.....</i>	36
	<b>GUARANTEE.....</b>	<b>39</b>

# 1. GENERAL INFORMATION

## Introduction

1. This appliance is suitable for installation in GB and IE and should be installed in accordance with the rules in force.

In GB, the installation must be carried out by a Gas Safe Registered Installer. It must be carried out in accordance with the relevant requirements of the:

- Gas Safety (Installation and Use) Regulations.
- The appropriate Building Regulations either The Building Regulations, The Building Regulations (Scotland), Building Regulations (Northern Ireland).

Where no specific instructions are given, reference should be made to the relevant British Standard Code of Practice (see item 2).

In IE, the installation must be carried out by a Competent Person and installed in accordance with the current edition of I.S.813 "Domestic Gas Installations", the current Building Regulations and reference should be made to the current ETCI rules for electrical installation.

On completion of an installation in IE, it is necessary to complete a "Declaration of Conformity" to indicate compliance to I.S.813.

2. The installation of the fire should also follow the recommendations of the following current British Standards (or equivalent):

BS 6891	Pipe work Installation
BS 5440: Pts 1 & 2	Flues and Ventilation
IGE/UP/7	IGE document for gas installations in Timber Frame Buildings (Available from Institute of Gas Engineers and Managers)

3. In other EC countries equivalent rules in force must be used.
4. It is important for correct combustion of this fire that the imitation fuel is placed in accordance with the instructions given in this and associated booklets. Only approved imitation fuel, available from Burley Appliances Ltd., should be used with this appliance.
5. It is recommended that a fire guard complying with BS 8423 be fitted for the protection of young children, the elderly or infirm.
6. Ensure that curtains are not positioned above the appliance and there is at least 300mm between the sides of the appliance and any curtains.
7. Combustible shelves or materials must only be fitted above the fire in accordance with the instructions given in this and associated booklets.
8. The user is warned not to remove the glass panel or to disturb the fuel bed.
9. **If any cracks appear in the glass panel do not use the appliance until the glass panel has been replaced (by a qualified installer).**
10. Ensure that the flue terminal is always kept clear of any obstructions (e.g. shrubs, plants, objects leaning against it, etc.).
11. It is important for the fire to be serviced regularly. An annual service is recommended.

## Ventilation Requirements

1. This appliance does not require any ventilation in the room where it is fitted. It is a balanced flue appliance whereby the air for combustion is drawn in from the outside and the products of combustion are evacuated to the outside through a concentric flue duct system.
2. In other EC countries, equivalent rules in force must be used.

## Gas Supply

1. This range of gas fires is suitable for use with Natural Gas (G20) at 20mbar supply pressure.
2. A separate means of isolating the gas supply should be provided near to the appliance to facilitate servicing. An isolation valve (with a pressure test point) has been supplied for this purpose.

## Electrical Supply

Not applicable to this range of appliances.

## Efficiency Declaration

The efficiency of this appliance has been measured as specified in BS EN 613:2001 and the results are 80% net. The gross calorific value of the fuel has been used for this efficiency calculation. The test data from which it has been calculated has been certified by BSI Ltd. The efficiency value may be used in the UK Government Standard Assessment Procedure (SAP) for energy rating of dwellings.

## Surfaces & Working Surfaces

It is recommended that a suitable fireguard be used for the protection of young children and the infirm at all times. All surfaces on the appliance are to be considered a working surface.

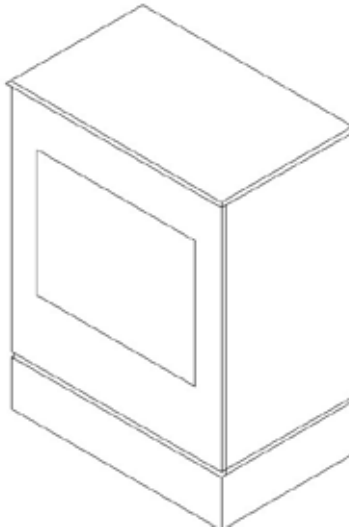

Figure 1

## 2. USER INSTRUCTIONS TO BE LEFT WITH CUSTOMER

### 2.1. *Location of Pilot Burner*

The pilot assembly is located just to the right of centre of the appliance, in front of the main burner.

The pilot flame can be viewed by looking downwards through the pilot hole in the front ceramic.

(See Figure 2).

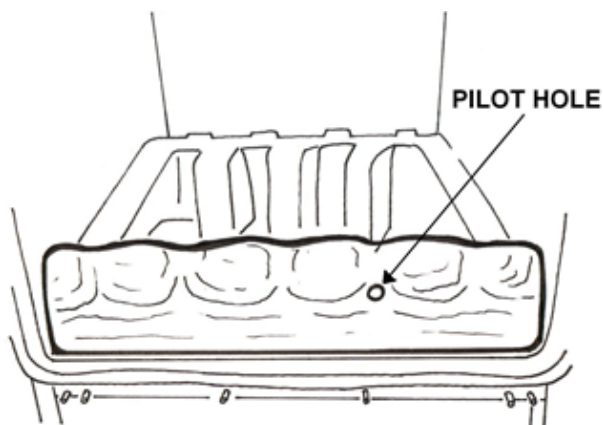





FIGURE 2. PILOT LOCATION

## 2.2. Lighting Procedure

Your fire will be fitted with one of the following different types of gas control valves. Identify the control system on your fire as shown and follow the appropriate operating instructions in the appropriate section.

Control Valve		Operation		Control Type
	+	Manual	=	<b>Manual Control</b> See <b>Sections 2.2.1</b> on <b>Page 8</b>
	+		=	<b>Total Control</b> See <b>Sections 2.2.2</b> on <b>Page 9</b>

## 2.2.1. Lighting Procedure (Manual Control)

1. Whilst pushing the IGNITION KNOB in (see **Figure 2**), turn it anticlockwise to the pilot flame position as shown in **Figure 3**. During this process, the spark ignition will have operated and lit the pilot flame. On lighting the pilot flame continue to depress the ignition knob for a further 15 - 20 seconds then slowly release. The pilot flame should stay alight. If the flame goes out, repeat the procedure above to establish the pilot. Due to safety and the efficient way the fire works, it is not unusual for the pilot to stay alight only after the second or even third attempt.
2. Turn the IGNITION KNOB anticlockwise to the main flame position as shown in **Figure 4**.
3. Turn the GAS RATE ADJUSTING KNOB fully anticlockwise (until you reach the stop position) i.e. the maximum gas rate. See **Figure 5**.
4. The main burner will have cross-lit from the pilot.
5. Now the gas rate can be adjusted to the desired setting by turning the GAS RATE ADJUSTING KNOB to any position between the pre-sets high and low.
6. To switch off the main burner turn the IGNITION KNOB to the 'Pilot burner only Position' as shown in **Figure 3**. The appliance may be left in this standby mode if desired.
7. To turn the pilot off turn the Ignition Knob on the control valve fully clockwise to 'A' position.

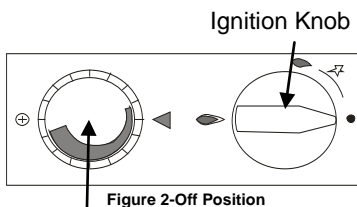

Gas Rate Adjusting Knob

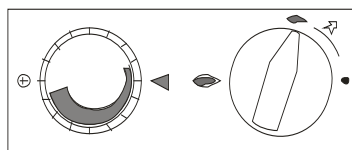

Figure 3- Pilot Burner Only

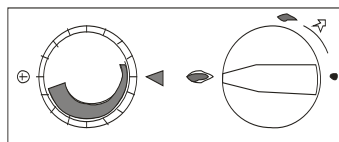

Figure 4- Main Burner Operational, but gas flow off

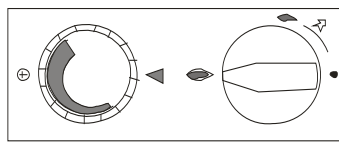



Figure 5- Main Burner Operational and Max. Gas Rate



## 2.2.2. Lighting Procedure (Total Control)

1. Ensure that gas is available at the valve and the ON/OFF switch in the ON position (-). (See **Figure 6**)
8. To **turn off** the main burner and the pilot press the 'OFF' button on the hand set.

2. Simultaneously press and hold the  (red circle) and  (large flame) buttons until a short acoustic signal confirms the start sequence has begun, then release the buttons (see **Figure 7**).

3. The pilot flame should stay alight. If the flame goes out repeat the procedure above to establish the pilot. Due to safety and the efficient way the fire works, it is not unusual for the pilot to stay alight only after the second or even third attempt.

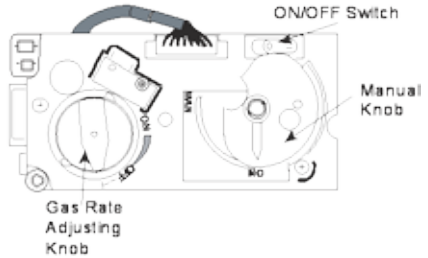







Figure 6

4. Continuing signals confirm the ignition is in process. **Once the pilot is lit the gas rate adjusting knob automatically turns to high gas rate.** The main burner cross-lights from the pilot.

5. To adjust the gas rate to desired setting press the  (large flame) to increase the flame height or  (small flame) to decrease the flame height on the handset (see **Figure 7**).

6. For fine adjustment tap the  or  buttons.

7. To leave the burner in the **standby mode** press the  (small flame) until the main burner goes out. In the standby mode, the pilot stays alight.

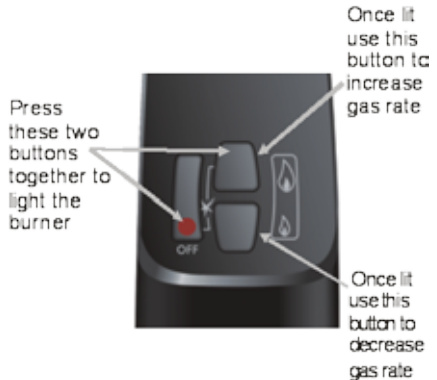

Figure 7

## 2.3. Battery Replacement (Remote Control)

### 2.3.1. Handset

1. On the reverse of the handset, remove the battery cover by pressing in at the top of the cover and sliding it down. (See **FIGURE 8**)
2. Remove and unclip the old battery and replace with a new PP3 9V battery.
3. Replace the cover by sliding it back up.

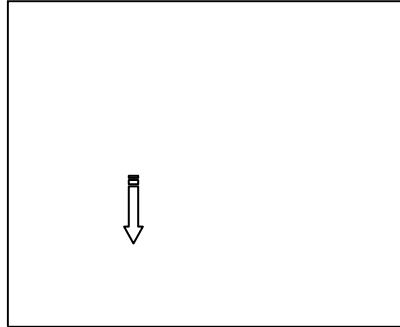

FIGURE 8 HANDSET BATTERY REPLACEMENT

### 2.3.2. Receiver Unit

1. Remove the receiver unit from under the stove. Remove the battery compartment cover by sliding it back. (See **FIGURE 9**).
2. Remove and unclip the old batteries and replace with new ones, (4 x AA 1.5V) ensuring they are inserted in the correct polarity.
3. Replace the cover on the receiver unit, ensuring that it is securely closed.
4. Return the receiver unit to its original position as far back as possible & replace the heatshield.



FIGURE 9 RECEIVER BATTERY REPLACEMENT



With the exception of battery replacement, the receiver / battery holder must be placed on the floor, (hearth) under the appliance as far back as possible with the heatshield replaced over it.

## **2.4. Home Improvements**

**NOTICE: Discolouration of wall surfaces near the appliance**



Generally, heating appliances will create warm air convection currents that will transfer heat to any surface against which they are located.

Some soft furnishings (including blown vinyl wallpapers) may not be suitable for use, where they are likely to encounter temperatures above the normal room level. For this reason, the manufacturer's advice should be sought before using this type of wall covering adjacent to any heating appliance.

The likelihood of wall staining, caused from convection air currents, will be increased in areas where high levels of tobacco smoke, or other contaminants, exist.

## **2.5. Cleaning and Care Instructions**

---

### **2.5.1. Painted Metal Surfaces**

These surfaces should be dusted regularly and any marks removed with a soft damp cloth. Do not leave the appliance wet. A soft brush may be used to clean dust deposits from any cast iron surface. This should be done only when the appliance is cold. Cans of touch-up paint are available to re-paint the surfaces of the appliance.

Any other maintenance of the product must be carried out by a Gas Safe engineer.

---

### **2.5.2. Glass Surfaces**

Only clean the glass when the appliance is cold and the pilot is not lit. The outside of the glass can be wiped clean with a soft damp cloth. Do not leave the appliance wet. If the inside of the glass is dirty, please get a Gas Safe engineer to investigate, and clean the glass.

# 3. INSTALLATION INSTRUCTIONS

FOR USE BY THE 'GAS SAFE' ENGINEER

**THIS APPLIANCE MUST BE INSTALLED AND COMMISSIONED BY A 'GAS SAFE ENGINEER'**

Before installation, ensure that the local distribution conditions, identification of the type of gas and pressure, and the adjustment of the appliance are compatible.

## 3.1 General Safety Requirements

Before commencing installation, ensure that the intended installation will comply with details in **General Information** on Page 4.

The installation of the fire should follow the recommendations of the following current British Standards (or equivalent):



BS 6891

BS 5440: Pts 1 & 2

IGE/UP/7

Pipe work Installation

Flues and Ventilation

IGE document for gas installations in Timber Frame Buildings (Available from The Institute of Gas Engineers and Managers)

Combustible shelves or materials must only be fitted above the stove as described later in this section.

Ensure that curtains are not positioned above the appliance and there is at least 300mm between the sides of the appliance and any curtains.

## 3.2 General Dimensions

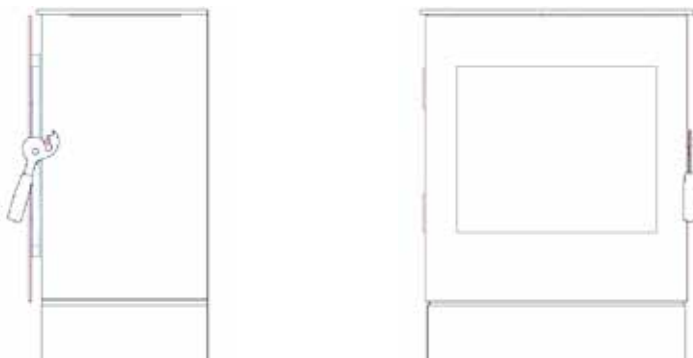

FIGURE 10. General Dimensions (Side and Front)

### SYMMETRY CUBE

Height  
Depth  
Width  
Weight

633mm  
380mm  
490mm  
45kg

### 3.3 Flue Options

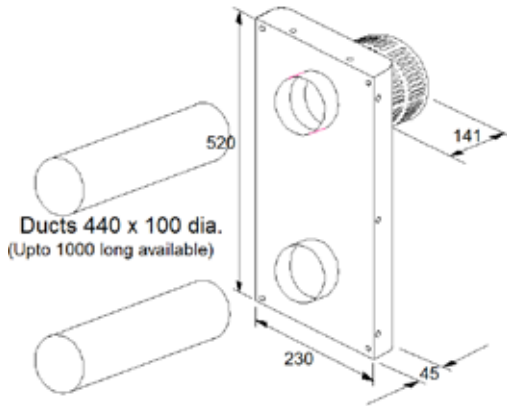

FIGURE 11 Flue Pipe and Air Box with terminal (all dimensions in mm)

The horizontal length of the ducts is measured from the rear of the outer firebox of the appliance to the external face of an external wall. The maximum length allowed is 980mm. As the stove must be spaced at least 30mm from the rear wall, the maximum wall thickness that can be accommodated is 860mm.

### 3.4 Technical Data

TECHNICAL DATA	Natural Gas (G20)
Nominal maximum heat input (hot)	4.0kW (gross)
Nominal minimum heat input (hot)	2.3 kW (gross)
Setting pressures (cold) Max	7.0 ± 0.5 mbar
Setting pressures (cold) Min	2.0 ± 0.2 mbar
Gas Rate	0.36 m <sup>3</sup> /h
Injector Size Multiport	7x Ø 0.77mm
Gas Inlet Connection	8 mm Compression
Pilot	Polidoro 440.0333.11
Pilot Injector	2x Ø 0.27mm
Efficiency	80% net (Class 1)
Weighted NOx	119mg/kWh (Class 4)
Max / Min length of flue duct	1000mm / 150mm
Standard length of duct supplied	440mm

TABLE 1

## **3.5 Appliance Location**

The appliance is designed to be fitted through a non-combustible back panel mounted on an outside wall. Alternatively the appliance may be fitted into a false chimney breast, a deep rebated fire surround or a redundant fireplace, sited on an outside wall. The appliance may be sited at floor level or as a raised 'hole in the wall' installation.

1. In all installations we recommend a non-combustible back panel is fitted behind the appliance, taking into consideration the 30mm clearance requirement between it and the rear of the appliance. A flue spacer is supplied for this purpose. We do not recommend installing the appliance against a plastered wall without a back panel. The non-combustible panel should extend at least 300mm above the top of the stove and be at least the width of the stove, plus 150mm each side. While the temperature of the wall behind and above the stove does not reach a dangerous level, there is still a risk that the plaster may crack, or the wall covering may be marked.

2. **Hearths, floor protection and carpets**

This appliance does not need a hearth and can be used on wooden, laminate floors and non-combustible surfaces. It must not be placed directly onto carpets or rugs. Where the floor is carpeted, the carpet must finish 100mm clear of the appliance base and be fully removed underneath. Loose rugs should be kept well away from the appliance (warn the customer of this).

Standing the appliance directly on a floor can lead to discolouration and / or drying out.

When a hearth is used, the top surface can be wood but be aware that heat can discolour certain finishes over a period of time and can dry out poorly seasoned wood causing splitting. The hearth should be 100mm larger than the appliance all round and minimum 12mm thick. Carpets can come to the edge of the hearth.

The different types of wall materials have different installation requirements. If the appliance is to be installed in a timber framed building, the recommendations of **IGE/UP/7 Edition 2 Gas installations in timber framed and light steel framed buildings** available from the IGEM must be followed.

### 3.5.1 Clearances to Combustible & Non Combustible Surfaces

1. Shelves or mantels made from combustible materials should not be placed closer than 300mm above the appliance.
2. Light coloured and resin mantels may discolour in time. The temperature rating of any surround should be checked before use.

**NOTE:** Please see the diagrams on the following pages to see the temperatures recorded with the appliance at maximum output. These are rises in temperature above the ambient.

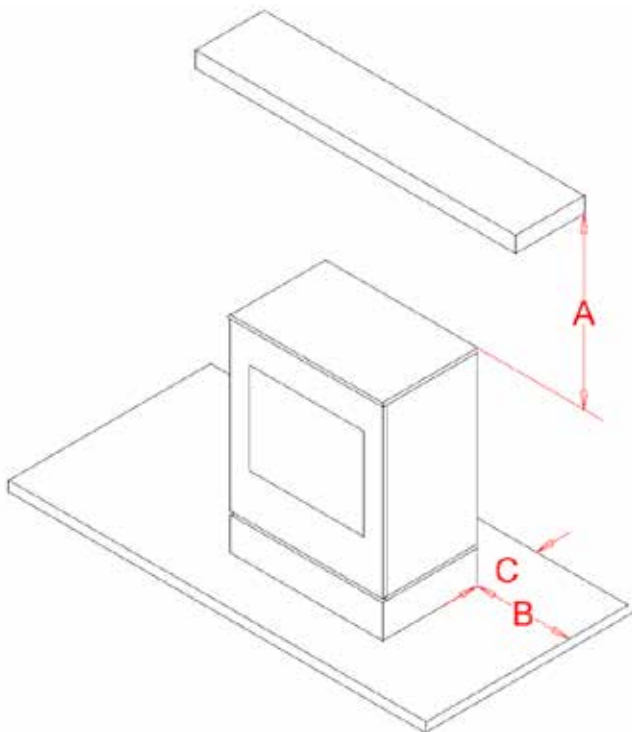

	CLEARANCE TO A COMBUSTIBLE	CLEARANCE TO A NON COMBUSTIBLE
<b>A (above)</b>	<b>300 mm</b>	<b>200 mm</b>
<b>B (each side)</b>	<b>150 mm</b>	<b>100 mm</b>
<b>C (behind)</b>	<b>200 mm</b>	<b>30 mm</b>

The hearth must be made from a suitable material such as board, steel, tiles or glass. The minimum thickness of this material is 12mm. Please ensure that the hearth can accommodate the weight of the appliance and its unsupported flue components.





The diagram below shows the increase in temperature of a decorative shelf in degrees Celcius with the appliance at maximum output. The ambient temperature of the room was 20°C.

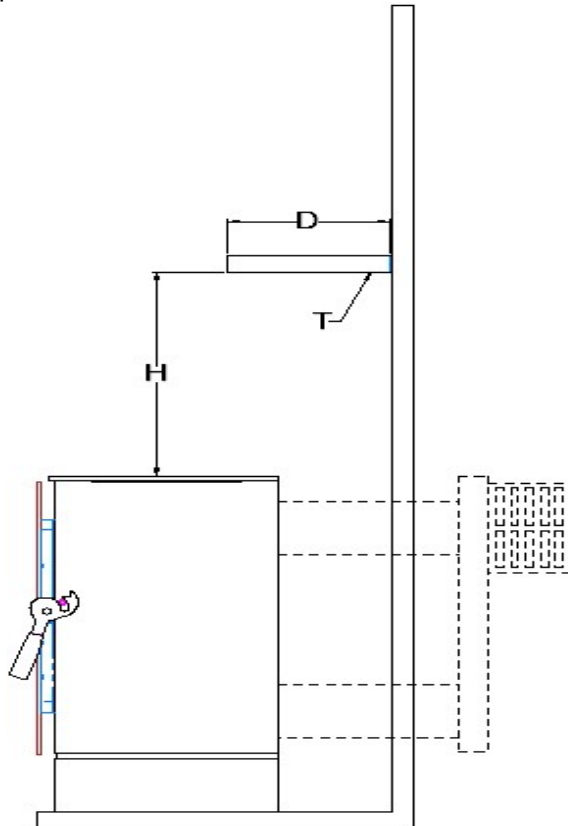

Increase in temperature of a decorative shelf

Height of Shelf above top of Stove mm	Temperature Rise (T°C)	
	Shelf Depth (D mm)	
	100	200
200	69	73
300	60	53
400	54	40
500	41	34
600	34	26

## 3.6 Flue Terminal Location

The minimum acceptable dimensions from the flue terminal to obstructions and ventilating openings are shown in **Table 2** and **FIGURE 12**.

Dimension	Terminal Position	Value mm
<b>A</b>	Directly below an opening, air brick, opening windows, etc.	300
<b>B</b>	Above an opening, air brick, opening window, etc.	300
<b>C</b>	Horizontally to an opening, air brick, opening window, etc.	300
<b>D</b>	Below gutters, soil pipes or drain pipes	300
<b>E</b>	Below eaves	300
<b>F</b>	Below balconies or car port roof	600
<b>G</b>	From a vertical drain pipe or soil pipe	300
<b>H</b>	From an internal or external corner	600
<b>I</b>	Above ground, roof or balcony level	300
<b>J</b>	From a surface facing the terminal	600
<b>K</b>	From a terminal facing a terminal	600
<b>L</b>	From an opening in the car port (e.g. door, window) into the dwelling	1200
<b>M</b>	Vertically from a terminal on the same wall	1500
<b>N</b>	Horizontally from a terminal on the same wall	300

Table 2

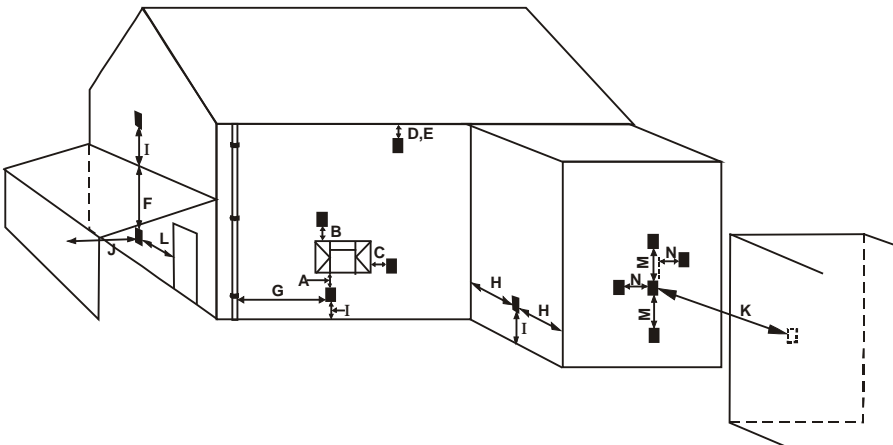

FIGURE 12

## 3.7 Flue Components

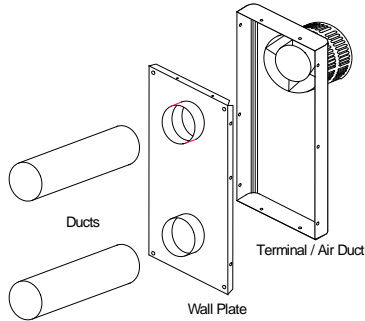

FIGURE 13 PARTS OF THE FLUE KIT

## 3.8 Contents Checklist

Before proceeding with the installation of the appliance, please check the contents of the cartons as follows:

Quantity	Items in CARTON 1
1 Assembly	Balanced flue gas stove assembly (with glass fitted).
1	Door packed separately in box
1 Guard	Terminal Guard

Quantity	Items in CARTON 2
1 Box	Fuel Effect Pack
1	Terminal (Terracotta)
1 Bag	Containing documentation, fixing kit, isolating valve & handle
1 Tub	Fire Cement
1 Tin	Black spray paint to touch up body work
2	Flue duct 440mm
1	Ash pan with 2 magnets

Quantity	Additional items ( <i>Remote Control Option Only</i> )
1 box	Remote Control Handset and Receiver, 4 off AA Batteries, 1 off PP3 (9V) Battery

## 3.9 Installation Procedure



Before commencing installation, ensure that the intended installation will comply with details in **General Information** on Page 4.

Carefully unpack the contents of the appliance carton and check them against the checklist given on the previous page.

### 3.9.1 Pre-Installation Procedure

#### Appliance

1. Remove the wrapped door
2. Carefully lift of the stove body and place thoughtfully to one side
3. Unpack the Balanced flue gas fire assembly from its carton.
4. Using a suitable 7mm socket remove the 14off glass frame retaining nuts and lift off the glass frame. Place them in a safe place.

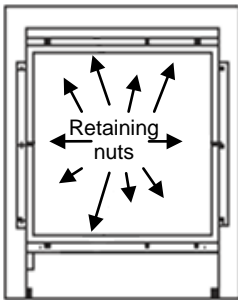
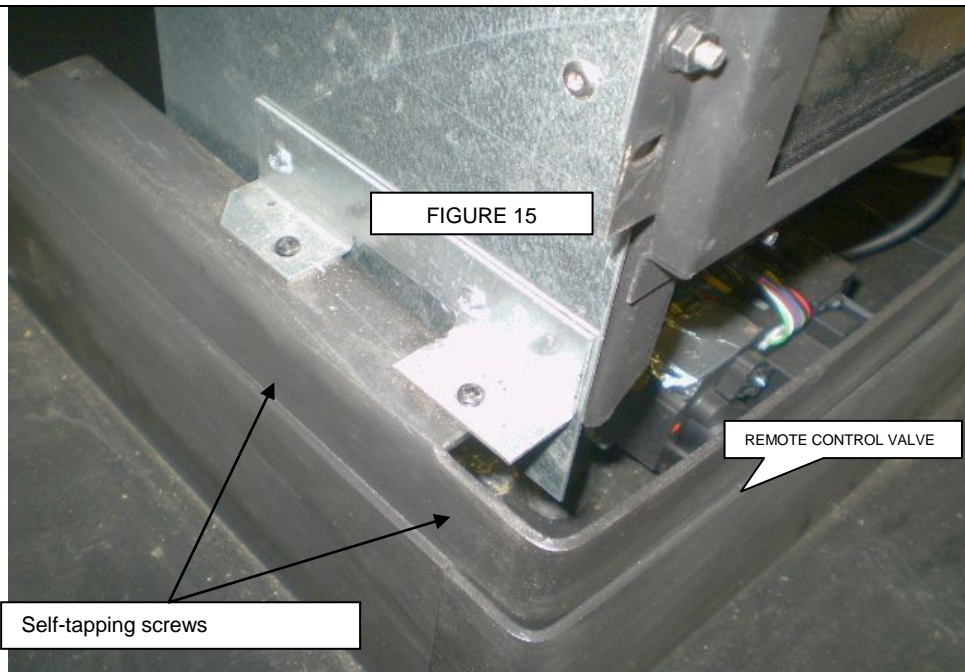

FIGURE 14 GLASS FRAME RETAINING NUTS

### 3.9.2 Assembling the Stove Outer Casing and Burner

**A QUICK OVERVIEW.** The gas fire burner box assembly is separate from the decorative outer casing. The base of the outer casing is screwed to the burner box assembly. Once the burner assembly is mounted on the base, this sub assembly can be installed as the 'gas fire', before the final decorative casing is fitted to the installed appliance. Please read the step by step instructions below.

1. Remove the base of the outer casing from its packaging.
2. Lift the balanced flued burner box assembly onto the outer casing base & fix via the brackets (2 off) to the side of the balanced flued burner box using the 4 self-tapping screws provided. See fig.15 overleaf.



Once the balanced flue gas fire assembly is screwed to the base casing (as shown above), the next stage is to prepare the fireplace for the installation of this 'sub assembly'.

- 3 Unpack the Spacer Bracket and secure it to the rear top of the firebox using two screws supplied (see Figure 16).

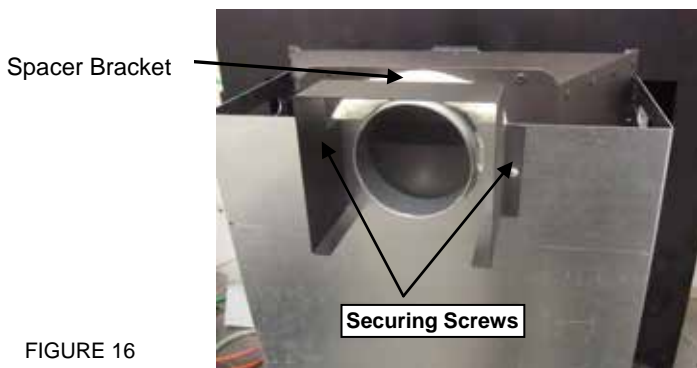
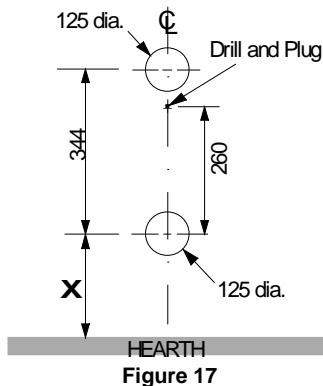

FIGURE 16

- 4 Fit the isolation elbow onto the gas inlet tubing on the control valve and proceed to the next stage of preparing the installation.

### 3.9.3 Installation Procedure for Non-Combustible Walls

1. Place the appliance in position on the hearth with the spacer bracket touching the 'non-combustible wall' immediately behind the appliance.
2. Measure the distance between the top of the hearth and the centre of the bottom spigot on the stove assembly ( X ).
3. On the wall mark a vertical centre line at the position the stove is to be sited. Mark the position of the bottom flue hole by measuring 'X' from the top of the hearth on the centre line. (See **Figure 17**)
4. Vertically above this first hole position on the centre line at a distance of 344mm.
5. Drill the two Ø125mm holes for the flue ducts in the previously marked positions. Ensure that any cavity wall insulation, or other combustible materials within the installation, are removed and replaced with Rockwool® or equivalent material, to the correct thickness.
6. On the centre line mark, drill and plug the hole for the eye bolt (for cable fixing if required) as shown in **Figure 17**. Screw in the eye bolt.
7. Return the stove onto the hearth and position it in front of the wall. Align the spigots on the rear of the appliance against the 125mm diameter drilled holes.
8. Take the flue ducts supplied, and from outside, push them through the wall onto the flue duct spigots that are mounted on the rear of the appliance. Make sure they are fully pushed home. With the appliance spaced correctly against the wall (using the spacer supplied) inside the property, go outside and mark both flue ducts at the external wall surface. (Note; Two 440mm lengths of Ø100mm ducts are supplied as standard. This is sufficient for most installations. Longer lengths of flue duct, up to 1000mm can be supplied. This is the maximum length of flue duct that is permitted to be used.)



**Figure 17**

9. Withdraw both the ducts and cut them squarely at the mark made in the above step. Deburr the ends of the ducts.
10. Paint any exposed area of the upper flue duct with high temperature black paint.
11. Apply fire cement around the spigots on the rear of the appliance and push the two lengths of flue duct through the wall and onto the spigots. Ensure that the ducts are pushed fully home.

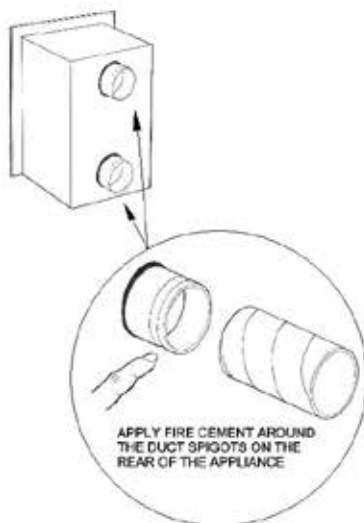

**FIGURE 18**

### 3.9.4 Fixing the Terminal

1. Unpack the Air duct/Terminal assembly and unscrew the painted outer cover with the terminal from the wall plate.
2. On the outside wall insert the spigots on the wall plate into the ducts ensuring that it is the right way up i.e. double spigot uppermost (see **Figure 19**).
3. Mark the four fixing positions for the wall plate onto the wall and remove the wall plate.
4. Drill and plug the marked positions using suitable sized drill bit.
5. Fill the gaps between the flue ducts and the wall with mineral wool, Rockwool® or equivalent material.
6. Apply fire cement around the two spigots on the back of the wall plate and engage the spigots with the two ducts from the rear of the appliance. **The spigot in front of the wall plate must be uppermost.**

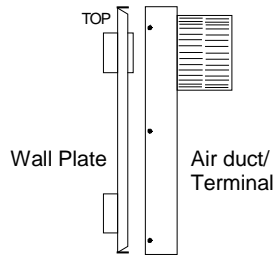

**Figure 19**

7. Push the wall plate fully home and fix in position with appropriate screws.
8. Screw the outer cover and terminal back onto the wall plate. Apply a bead of mastic around the periphery of the wall plate to prevent water ingress.
9. If the centre of the terminal is within 2 metres of the ground or a balcony a terminal guard must be fitted.

### 3.9.5 The Gas Supply

1. The gas supply can be fed to the appliance from underneath. Care should be taken to sleeve the pipe when passing through masonry.
2. An 8mm isolating valve (with a pressure test point) has been supplied with this fire to facilitate isolation of the fire during servicing.
3. The gas supply to the fire must be carried out using rigid or semi-rigid tubing.
4. Connect the outlet of the isolating valve to the inlet of the control valve on the fire tray. The outlet on the isolating valve is the one nearest to the pressure test point.



**Figure 20**

#### **ISOLATING VALVE WITH TEST POINT**

5. Once the gas connection has been completed, follow the instructions for the correct positioning of the logs or coals, in Fuel Effects Layout section.



---

## **Continuation of Installation – Optional Total Control Model**

1. Unpack the box containing the Receiver and the Hand Set.
2. Fit four AA (1.5V) batteries into the receiver unit and the PP3 (9V) battery into the transmitter (hand set).
3. Feed the cables from the valve through the heat shield and connect to the receiver as shown in **Figure 21**, keeping the cables clear of the underside of the tray.

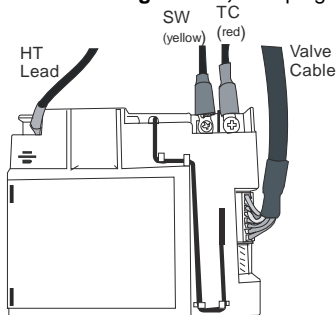

**Figure 21**

4. Do not force the valve cable plug when inserting into the receiver – it only fits one way.
5. Test the operation of the drive motor using the hand set as per Users Instructions (**Section 2.2.2 Lighting Procedure (Total Control) on Page 9**)

---

## **Replacing the Receiver (Total Remote Control)**

1. Pull out the receiver from under the fire and remove the batteries.
2. Gently pull out the HT lead and the valve cable from the receiver (see **Error! Reference source not found.**).
3. Unscrew and remove the SW and TC connections.
4. Refit in reverse order. (The valve cable plug fits into the receiver in one way only).
5. Replace the batteries and return the receiver under the heat shield.

---

## **Programming Handset to Receiver (Total Remote Control)**

If for some reason the remote handset requires re-programming to operate the receiver follow the procedure below:

until you hear an additional long acoustic signal confirming the new code is set.

1. Press and hold, using a pointed object, the receiver's reset button until you hear two acoustic signals (see **Error! Reference source not found.**).
2. After the second longer acoustic signal, release the reset button and within the subsequent 20 seconds, press the  (small flame) on the remote handset

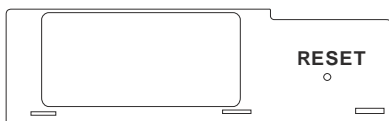

### 3.9.6 Fuel Effects Layout

It is recommended that the imitation fuel be left alone once the desired flame pattern has been achieved. **Constant moving of the imitation fuel will cause the fuel to disintegrate and/or cause discolouration.**



**Due to the nature of this appliance, any 'work' regarding the Fuel effect layout should only be carried out by a Gas Safe Registered Installer**

#### **Refractory Ceramic Fibres (RCF) advice:**

This product may use Components (Fuel Effects & Ceramic backs) containing Refractory Ceramic Fibres (RCF), which are man-made, vitreous silicate fibres. Excessive exposure to this material may cause irritation to eyes, skin and respiratory tract.



Therefore, during installation and servicing, we recommend that you use a HEPA filtered vacuum to remove any dust and soot accumulated in and around the fire before and after working on the fire. This is to ensure that the release of fibres from these RCF articles is kept to a minimum.

We recommend that you should follow the normal hygiene rules of not smoking, eating or drinking in the work area.

When replacing Components containing Refractory Ceramic Fibres (RCF), we recommend that the replaced items are not broken up, but are sealed within heavy duty polythene bags and clearly labelled as RCF waste. RCF waste may be disposed of in suitably licensed landfill sites.



**WARNING:** Do not touch the fire when it is alight. The fire will remain very hot for a while after extinguishing, as will the artificial coals and logs.

### 3.9.7 Coal / Log Effect Layout

The fire is supplied with a ceramic fuel set as follows:

	Qty
Front Ceramic	1
Rear Ceramic	1
Moulded Matrix	1

Proceed with the layout as follows:

1. Position the rear burner ceramic in position behind the rear burner flange, as shown in **Figure** .
2. Place the front burner ceramic in its support in front of the burner as in **Figure** . Manipulate the rear ceramic so that the front ceramic slides in easily.
3. Place the moulded coal matrix on top of the base ceramic so that the front rests on top of the front ceramic. Manipulate it so that the contour of the underside of the matrix corresponds to the top of the front ceramic.

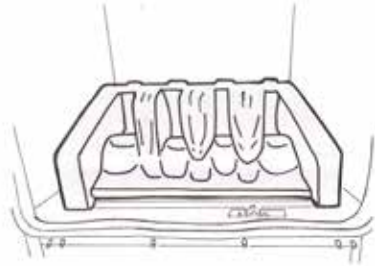

Figure 21 – Rear Ceramic

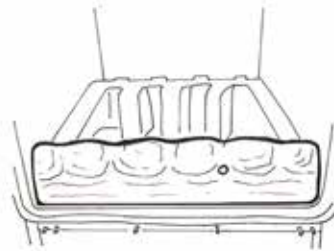

Figure 22 – Front Ceramic

### 3.9.8 Fitting the Glass Panel and frame

5. Fit the glass panel/frame to the front of the appliance, taking care not to move any of the ceramic logs or coals. Secure glass in position using the previously removed nuts. (see **Figure 30**)
6. To ensure a good seal tighten the nuts in a diagonal sequence a few turns at a time.
7. Fully tighten all the retaining nuts. **Do Not** use power tools to tighten the nuts.
8. Do not over-tighten the nuts and ensure that the seal behind the frame is gas tight.

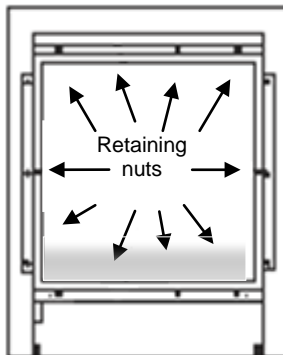

FIGURE. 23 GLASS FRAME RETAINING NUTS

### 3.9.9 Assembling Outer Casing

Now that the burner sub assembly has been installed as the 'gas fire', the decorative casing can be fitted to the installed appliance. Please read the instructions below.

**The outer casing weighs approx. 25kgs, an assistant may be required to help.** Lift the outer casing until the rear location supports just pass between the **bottom** of the glass frame & the top of the base unit. Place the outer casing over the base unit as far back as possible. Lift the front of the outer casing & engage the 2 front supports.

See **Figure 24**

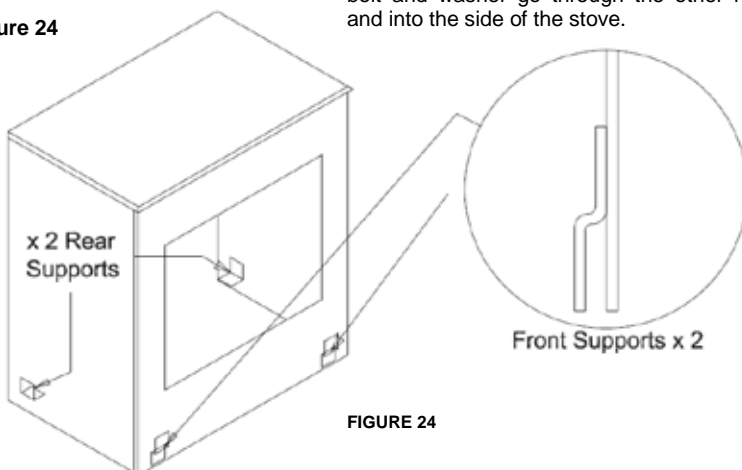

FIGURE 24

The outer case is an exact fit on the base and the rear lower edges may need to be sprung slightly to fit over the base.

#### Fitting the Door

The door should be lowered onto the hinge pins. Swinging the door open and closed slightly will help drop the door into the correct position

Fit the handle, the handle is decorative only and is designed to keep the door closed. The hole furthest from the wooden handle fits over the peg in the side of the stove and the bolt and washer go through the other hole and into the side of the stove.

---

### **3.9.10 Commissioning**

1. Turn on the gas supply to the fire and purge the gas line. Check all the gas joints for gas soundness.
2. Connect a pressure gauge to the pressure test point on the isolating valve.
3. Ignite the pilot in accordance with the User Instructions.
4. Set the controls to give full gas rate at the main burner. Check that the main burner cross lights smoothly.
5. Ensure that the pressure at the pressure test point is  $20 \pm 1.0$  mbar for natural gas.
6. If the correct pressure cannot be achieved, then some potential causes of low pressure are:
  - a) Supply pipes are not of large enough diameter.
  - b) The supply pipes are kinked, blocked or partially blocked.
  - c) Restriction at the appliance isolation valve.
7. Set the control to the low rate position (small flame image) and ensure that the flames reduce in size.
8. Turn the fire off.
9. Replace the screw in the pressure test point.

---

### **3.9.11 Instructing the User**

The installer must hand over these instructions to the user and explain how to operate this fire, stressing the importance of having the fire checked and serviced regularly. An annual service is recommended.



It is mandatory as part of the gas installation that the installer instructs the user on the correct operation and care of their appliance.

# 4 SERVICING INSTRUCTIONS

## 4.1 General Requirements

All repairs and servicing must be carried out by a qualified registered gas installer (e.g. member of Gas Safe Register in GB) in accordance with the current Gas Safety (Installation and Use) Regulations and these instructions.

Before any servicing is carried out ensure that the gas supply is turned off.

Always check for gas soundness after dismantling or exchange procedures.



**CAUTION:** Ensure that the appliance is off (including the pilot light) and has completely cooled (off for at least 2 hours) before carrying out any cleaning or maintenance.

### RCF Advice:

This product may use Components (Coals, Pebbles & Ceramic backs) containing Refractory Ceramic Fibres (RCF), which are man-made vitreous silicate fibres. Excessive exposure to this material may cause irritation to eyes, skin and respiratory tract.



Therefore during installation and servicing we recommend that you use a HEPA filtered vacuum to remove any dust and soot accumulated in and around the fire before and after working on the fire, to ensure that the release of fibres from these RCF articles is kept to a minimum.

We recommend that you should follow the normal hygiene rules of not smoking, eating or drinking in the work area.

When replacing Components containing Refractory Ceramic Fibres (RCF), we recommend that the replaced items are not broken up, but are sealed within heavy duty polythene bags, and clearly labelled as RCF waste. RCF waste may be disposed of in suitably licensed landfill sites.

Most servicing operations on this appliance will require the stove body panels to be removed. Refer to the appropriate section for details of how this is done.

---

### 4.1.1 *Cleaning the Fuel Effect, Fire-bed and Combustion Chamber*

1. Remove the outer-casing (this weighs 25kgs, an assistant may be required) by lifting it until the locating lugs just clear the base & carefully pull forwards.
2. Remove the glass door panel and place it in a safe place.
3. Carefully remove all the fuel bed ceramics from the fire. Lift out the front and rear ceramics. Any debris/dust or soot can be brushed off using a **soft brush**.
4. Remove the two screws securing the burner and gently lift it out of the appliance. Clean the burner slot with a brush and check that the venturi is clear.
5. Check that the electrode sparks across the gap when the ignition knob is operated.
6. Use a vacuum cleaner to remove any fluff or lint on the base of the combustion chamber.
7. Refit the burner and secure in place using the previously removed screws.
8. Replace the front and rear ceramics and relay the fuel bed as described in the appropriate fuel bed layout sections.
9. Refit the glass/frame and secure in place using the previously removed nuts. Refit the infill plate.
10. The flue ducts can be inspected and cleaned by removing the terminal/outer cover.
11. Re-assemble the outer-casing.

---

### 4.1.2 *Cleaning Lining Board Panels*

Any soot or dust marks on the side, top or rear panels can be cleaned by lighting dusting them with a very soft brush.



**NOTE:** Any attempt to clean the lining panels using an alternative method, will result in irreparable damage leading to a replacement being required.

---

### 4.1.3 *Care of Lining Panels*

The lining panels on this appliance must NOT be sprayed with any type of solvent-based high temperature paint.

The very high temperatures produced within the appliance will cause the paint to bubble and/or burn off rendering the fireback looking unsightly.

Minor surface scuffs may be treated using a water based touch up stain available at Burley fire retailers.



Extreme care should be taken when handling and installing products containing ceramic fibre board, so as not to cause damage.



## 4.2 Replacing Parts

For any spare parts that are required, please contact either your supplier or the manufacturer directly. You will need the model name i.e. model number, the gas type, the type of control and serial number. Servicing and repairs to your appliance must be carried out by a Gas Safe engineer.

**Only approved parts must be used. Isolation of the appliance from the gas supply will be necessary, before any 'work' is carried out.**

---

### 4.2.1 Burner Components Removal and Replacement

For ease of access to all the burner components, we recommend removal of the entire burner assembly from the decorative cast iron stove surround.

Please inspect the condition of any seals or spacers before re-assembly and replace if necessary.

Section 3.9 describes the installation procedure of the burner assembly into the decorative stove surround. Reverse this procedure till you have easy access to the component you wish to service or replace.

---

### 4.2.2 Pilot Components Removal and Replacement

1. Follow procedures 1 - 3 in the **Section 4.1.1** to gain access to the pilot assembly.
2. Pull off the electrode spark lead, loosen and remove the electrode clamp nut and remove the electrode. **Always remove the electrode when working on the pilot to prevent damage**
3. Loosen the thermocouple clamp nut and draw the thermocouple downwards. Due to heat and age the nut may have to be fully undone before the thermocouple can be removed.
4. Unscrew the 4mm pilot gas supply tube nut and ease the tube downwards. The pilot injector will probably fall out or it may have to be dislodged with a piece of wire.
5. To change the thermocouple the thermocouple nut will have be unscrewed from the rear of the control valve.
9. The pilot burner can now be removed by unscrewing the two screws and nuts on either end of the burner.
10. Before replacing the pilot burner check the condition of its gasket. Replace if necessary.

### 4.2.3 Injector Replacement

1. Remove the outer-casing of the stove.
2. Remove the glass door panel, the fuel bed components and the front and rear ceramics.
3. Lift out the top lining board, followed by the two sides and the back.
4. Remove the main burner. See **Figure 34**.
5. Grip the injector nose whilst undoing the injector tube nut.
6. Unscrew the two screws securing the burner/injector mounting bracket. Lift away the burner support bracket. Unscrew the injector securing nut.
7. Remove the injector and replace it with the new one and secure in position with the injector securing nut (do not fully tighten it at this point. Refit the injector tube nut.
8. Replace the burner support bracket and secure with two screws. Tighten the outer injector securing nut. Grip the injector nose and tighten the tube nut, making sure that the injector is correctly aligned.
9. Replace all the other components.

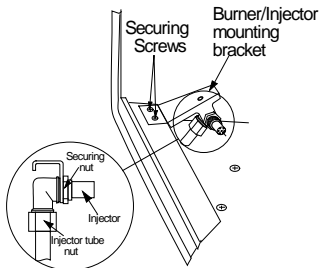

**Figure 25 INJECTOR DETAILS**

## 4.2.4 Control Valve Replacement (Manual Control /Total Remote Control)

For ease of access to all the burner components, we recommend removal of the entire burner assembly from the decorative casing.

Please inspect the condition of any seals or spacers before re-assembly and replace if necessary.

1. Once the burner assembly is safely removed, remove the spark lead from the electrode on the pilot burner.
2. Press the power switch on the valve to O.
3. Disconnect the thermocouple from the rear of the valve. Unscrew the gas connections from the valve.
4. Remove the old valve from the mounting bracket and replace with new one. If necessary, remove the tube adaptors from the old valve and fit them to the new valve.
5. Remake the gas connections.
6. Remove the valve cover by removing the securing screw and levering out the cover through the slot on the opposite side using a small screw driver.
7. Transfer all the tubing on the old valve to the new one, ensuring that the tubing positions are the same as before. Tighten all connections.
8. Refit the rest of the components in reverse order.
9. Reconnect the thermocouple to the rear of the valve, taking care not to kink the pipe.
10. Refit the valve in reverse order.
11. Refit the HT lead and remake all the gas connections.

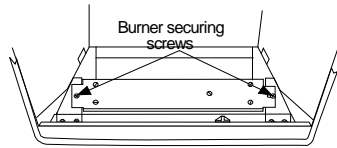
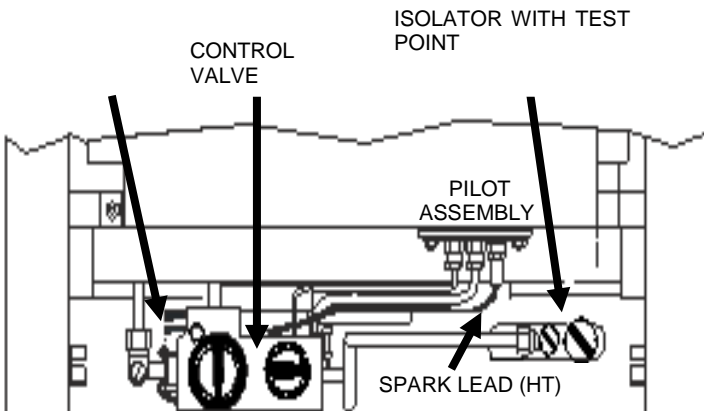

Figure 26 BURNER SECURING SCREWS



## 4.3 Installation and Operational Troubleshooting

The table below is intended for problems related to the fire and its gas controls. It is a guide only and does not take into account every eventuality. Servicing must be carried out in accordance with the current Gas Safety (Installation and Use) Regulations, by a competent person.

It is recommended that the purchaser seek the advice of the original installer in case of encountering any problems.

Symptom	Cause	Remedy
<b>No spark appears at the electrode</b>	a) Electrode cracked or broken	Replace electrode
	b) HT lead shorting out	Establish where spark is occurring and insulate or re-route lead accordingly.
	c) Faulty spark generator	Replace valve
	d) HT lead disconnected from electrode	Re-connect HT lead to electrode
<b>Piezo operates normally but pilot will not light</b>	a) No gas supply	Check isolation valve/supply
	b) Pilot jet blocked	Clean pilot jet
<b>Pilot lights, but goes out when control is released</b>	a) Loose thermocouple connection at control valve end	Remake thermocouple ensuring the connection is firm
	b) Faulty Thermocouple	Replace thermocouple
	d) Thermocouple not fully inserted into pilot burner	Loosen thermocouple clamp nut and push thermocouple fully upwards
<b>Pilot and main burner go out when control is set to high position</b>	a) Gas supply partially blocked	Locate restrict and remove faulty section
	b) Too many bends on gas inlet pipe	Increase diameter and/or reduce the number of bends
	c) Pilot jet partially blocked	Clean pilot jet.
	d) Restriction at Isolation valve	Ensure valve is fully open and that internal diameter is sufficient and free from grease



**Warning:** If you are in any doubt about the clearance of fumes, you must stop using the appliance immediately and seek expert advice. Do not use appliance until the fault has been rectified.

Remote Control		
Symptom	Cause	Remedy
Main burner will not come on when required even though the drive motor is heard to be operating	Ignition knob incorrectly set	Set the ignition knob at the 9 o'clock position.
Motor not functioning when buttons are pressed	a) Flat hand set battery (Remote Control)	Replace battery (1 X PP3)
	b) Flat batteries in receiver unit (Remote Control)	Replace all 4 AA batteries
Remote Control will turn fire off but will not turn on	Incorrect hand set operation	Ensure two buttons are pressed to turn on



**NOTE:** For any spare parts that are required, please contact either your supplier or the manufacturer directly. You will need the model name i.e. Model Number, the gas type, the type of control and serial number.

**Only approved parts should be used.**

*This page is left intentionally blank*

# Guarantee

Dear Customer,

Your gas appliance, when installed in accordance with the installation instructions and operated in accordance with these instructions, should provide many years of safe and efficient operation.

We thank you for purchasing our product and trust it will provide excellent service.

This appliance carries a guarantee of 1 year. The consumable components of this appliance are guaranteed for one year.

We agree to repair free of charge or, at our option, replace the appliance or part thereof, which may prove to be defective within the guarantee period.

In the unlikely event of a defect in materials or workmanship occurring within one year of purchase, please contact the shop from where the appliance was purchased.

Any claims under this warranty must be made through the retailer from whom the product was purchased.

The purchaser's contract of sale is with the retailer, not Burley Appliances.

We (Burley Appliances) are unable to enter into discussions with the purchaser, until the retailer has inspected any claim and deemed it to be valid.

Burley Appliances Fires reserve the right to refuse service or make a charge for any service call, when a defect is due to any of the following issues which will void your Guarantee.

The guarantee is void if:

- The appliance is not installed and operated in accordance with our instructions; or
- The appliance is not serviced, by a Gas Safe registered engineer, annually; or
- Repairs of modification have been carried out by the purchaser or any third party not authorized by us; or
- The appliance has been misused or accidentally damaged; or
- Damage is due to 'fair wear and tear'; or
- The appliance or defective component(s) are not returned to us, prepaid postage.

The rights given in this guarantee are limited to the UK mainland and are in addition to any to which you may have a statutory entitlement.

Please retain your purchase receipt; we may need to see this in the event of a claim under warranty.

Burley Magiglo fires are protected by  
UK patents 2193802, 2240620 and 2256920  
Other Patents Pending



**sbg**i



Burley Appliances Ltd, Lands End Way,  
Oakham, Rutland, LE15 6RB

Tel: 01572 725570 Fax: 01572 724390  
[www.burley.co.uk](http://www.burley.co.uk) Email: [info@burley.co.uk](mailto:info@burley.co.uk)