

# Installation Instructions & User Manual

for the super-efficient

burley  Fireball

## Wood Burning Stoves

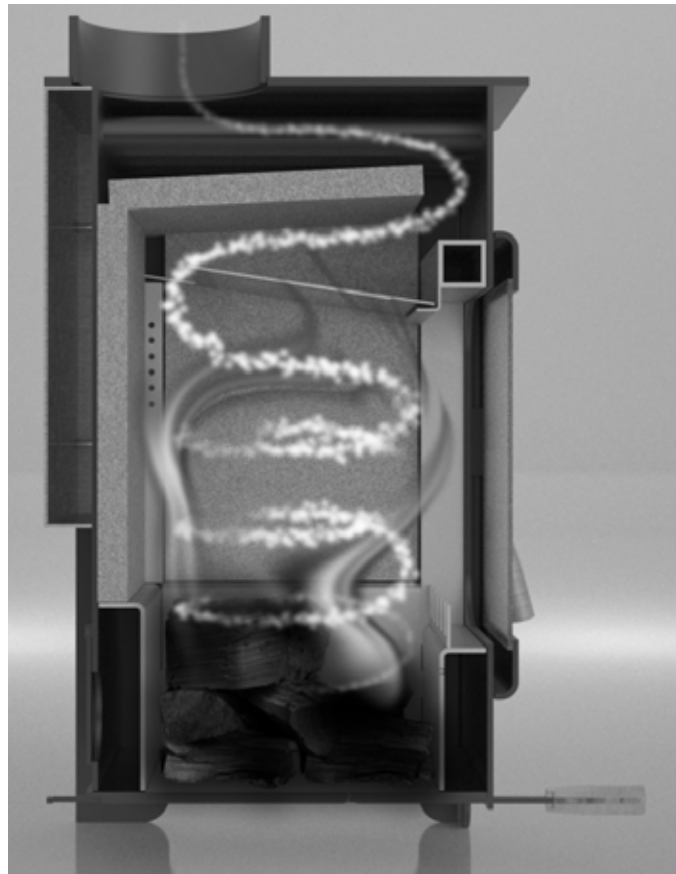

*Cross Section – Artist Impression*

### Applicable Appliances

**Springdale (9103), Debdale (9104), Hollywell (9105),  
Brampton (9108) and Wakerley (9112)**

Document reference BUR/06/16    Revision date: AUGUST 2016

**THESE INSTRUCTIONS MUST BE LEFT WITH THE USER  
FOR FUTURE REFERENCE**

# Table of Contents

Approvals .....	4
<b>TECHNICAL DATA</b> .....	5
Stove Dimensions .....	6
Room Sealing Options .....	6
Installation Instructions .....	7
The Clean Air Act 1993 and Smoke Control Areas .....	7
Chimneys, Flues, Hearths and Surrounds .....	8
Air Supply and Room Sealing Kit .....	9
Stove Assembly .....	10
Door Handle Adjustment .....	10
Door Handle Assembly .....	11
Air Lever Assembly .....	12
Optional Convection Tube Cover Plate .....	13
Assembly and Installation of the Stove Fire Bricks and Baffle .....	14
Fitting of Stove Bricks .....	14
Log Retaining Bar .....	14
Commissioning the Appliance .....	15
<b>USER INSTRUCTIONS</b> .....	15
To Light the Stove .....	15
Recommended fuels & using the Moisture Meter .....	16
 Stove Thermometers - DO NOT USE WITH OUR STOVES .....	16
Troubleshooting/Poor Appliance Operation .....	16
Reasons for Premature Wear of Internal Parts .....	17
Care of Glass .....	17
Chimney Sweeping and Maintenance .....	18
Safety .....	18
Warranty .....	19
If you need further help ... ..	19
Spare Parts .....	19
Customer & Installation Notes .....	20

**PLEASE CAREFULLY CHECK YOUR STOVE FOR DAMAGE  
OR DEFECTS PRIOR TO FITTING.**

**WE CAN NOT EXCHANGE DAMAGED OR FAULTY  
STOVES ONCE THEY HAVE BEEN FITTED.**

# Thank You

Thank you for purchasing a Burley Fireball Wood Burning Stove; we hope you will be delighted with the super-efficient performance.



Included with your stove is the Burley 'Thank You Kit'\*, which typically contains:-

- A Spanner to attach and adjust the tension of the air control lever
- A Coaster to protect the top of your stove
- Four Hearth Protectors (optional) to place under the stove legs [Black Squares]
- A Moisture Meter to ensure your wood is dry.
- Glass Cleaner
- Stove Paint in case you prefer black handles or ever need to touch up any paint work
- A Heat Resistant Glove
- Scoop for removing ash
- An Allen Key should you wish to adjust the door handle
- A Mug to enjoy a cup of tea whilst admiring the fantastic flame picture

The contents of the kits vary from model to model, so not all the items listed or shown above may be included with your stove.

\*Thank You Kit introduced with stoves supplied from October 2013

## Features...

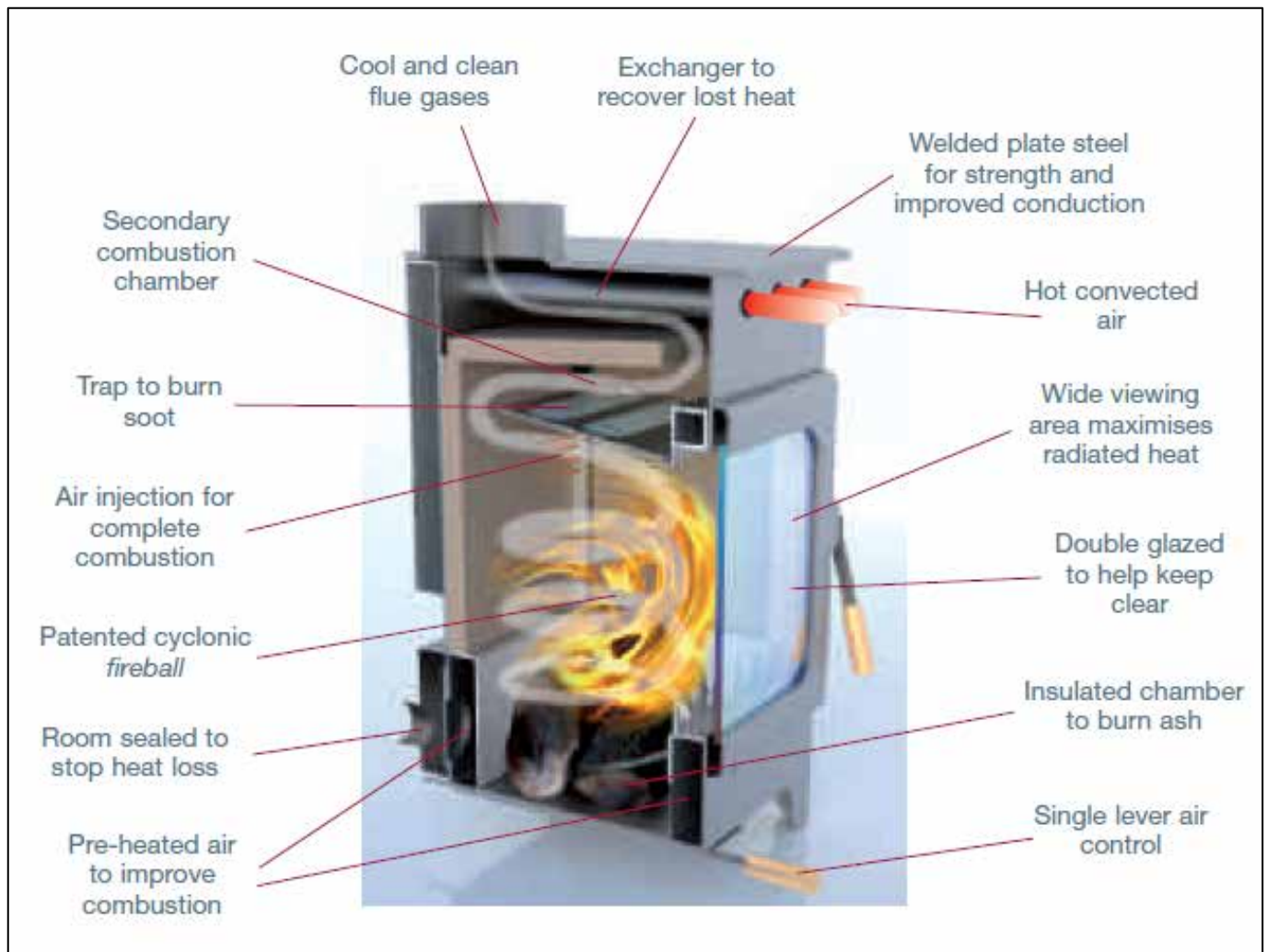

*Cross Section – Artist Impression*

**You now own the world's most efficient stove!**

## Approvals

All our wood stoves are approved to EN13240:2001 and EN13240 A2:2004.

# TECHNICAL DATA

All built to EN13240	Springdale 9103	Debdale 9104	Hollywell 9105	Brampton 9108	Wakerley 9112
Efficiency (Net)	88.9%	89.8%	89.1%	85.5%	84.1%
CO concentration @ 13% Oxygen	0.28%	0.28%	0.18%	0.12%	0.06%
Requirement of fuels used in Smoke Control Areas	Dry logs <20% H <sub>2</sub> O	Dry logs <20% H <sub>2</sub> O	Dry logs <20% H <sub>2</sub> O	Dry logs<20% H <sub>2</sub> O	<b>Not for Use in Smoke Control Areas</b>
	Maximum length 170 -220mm long	Maximum length 200 -250mm long	Maximum length 250 -300mm long	Maximum length 250 -350mm long	
	Maximum width 150mm	Maximum width 150mm	Maximum width 150mm	Maximum width 150mm	
Lower quality fuel can be used in non- smoke controlled areas, but will not give the best efficiencies	Dry Logs < 25% H <sub>2</sub> O	Dry Logs < 25% H <sub>2</sub> O	Dry Logs < 25% H <sub>2</sub> O	Dry Logs < 25% H <sub>2</sub> O	Dry Logs < 25% H <sub>2</sub> O
	220mm long	250mm long	310mm long	430mm long	580mm long
Weight in kg	45 kg	57 kg	95 kg	105 kg	130 kg
Nominal kW output	3 kW	4 kW	5 kW	8 kW	12 kW
<b>Max kW output</b>	<b>4.1 kW</b>	<b>5.3 kW</b>	<b>6.4 kW</b>	<b>11.7 kW</b>	<b>18.3 kW</b>
Air vent requirement.	Not Required	Not Required	550mm sq min in houses built after 2010, otherwise not required	1,962mm sq min 50mm diameter	7,850mm sq min 100mm diameter
			Air vent not required if stove is room sealed	Air vent not required if stove is room sealed	Air vent not required if stove is room sealed
Minimum flue draught mm H <sub>2</sub> O	0.5mm	0.5mm	0.5mm	0.5mm	0.5mm
Flue gas temperature	162 °C	156 °C	122 °C	183 °C	237 °C
Spigot Temp.	258 °C	253 °C	241 °C	274 °C	316 °C
Flue size (Top Exit)	127mm (5")	127mm (5")	150mm (6")	150mm (6")	150mm (6")
Min. chimney diameter	127mm (5")	127mm (5")	150mm (6")	150mm (6")	150mm (6")
Best chimney diameter	127mm (5")	127mm (5")	150mm (6")	150mm (6")	175mm (7")
Minimum distance to <b>combustible</b> materials. All other distance as per Building regulations Part J or HETAS recommendations	10cm behind (4") 35cm at side (14") 35cm to Top	20cm behind (8") 40cm at side (16") 40cm to Top	20cm behind (8") 35cm at side (14") 35cm to Top	10cm behind (4") 40cm at side (16") 40cm to Top	20cm behind (8") 45cm at side (18") 45cm to Top
Non combustibles	<b>When fitted inside a masonry or similar non-flammable material recess, e.g., fireplace opening, there is no minimum distance; although we would advise a minimum of 50mm from any surface to allow for convection.</b>				
Max Hearth temp.	<100 °C	<100 °C	<100 °C	<100 °C	<100 °C
Min Hearth thickness	12mm	12mm	12mm	12mm	12mm

# Stove Dimensions

## GENERAL DIMENSIONS

Stove	A	B	C
9103	370	495	296
9104	422	560	340
9105	470	680	405
9108	595	680	405
9112	750	780	405

## ROOM SEALING DIMENSIONS

Stove	D	E
9103	140	80
9104	140	80
9105	140	80
9108	140	80
9112	140	80

## PLAN VIEW

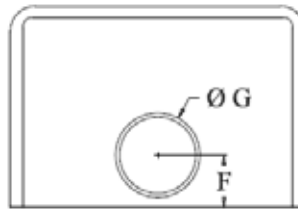

## FLUE SPIGOT DIMENSIONS

Stove	F	G
9103	97.5	127 (5")
9104	97.5	127 (5")
9105	105	152 (6")
9108	105	152 (6")
9112	105	152 (6")

## REAR VIEW

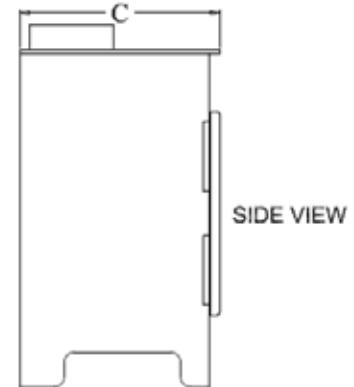
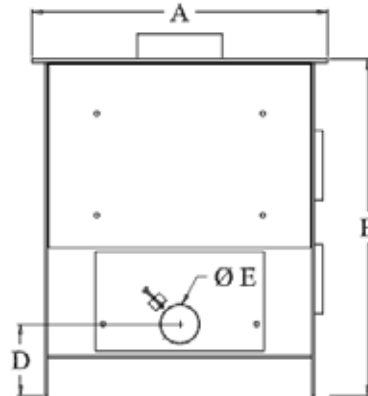

# Room Sealing Options

## BURLEY WOOD BURNING STOVES ROOM SEALING OPTIONS

### STANDARD REAR ROOM SEALING KIT THE KIT COMES WITH PARTS

- A. PLENUM BOX ASSEMBLY
- B. 1000MM X 80MM STEEL DUCT
- C. 80MM VENT COVER

### ANGLED ROOM SEALING BOX

- A. PLENUM BOX ASSEMBLY
- D. ADAPTOR BOX

THE ADAPTOR BOX (D) IS DESIGNED TO FIT THE FLAT CHANNEL DUCT SYSTEM 100 (SECTION 110MM X 54MM)

YOU WILL NEED TO SOURCE THE APPROPRIATE PARTS AS SHOWN ON THE RIGHT. EXAMPLES OF DIFFERENT ANGLED ARRANGEMENTS ARE SHOWN ON THE NEXT PAGE IN ILLUSTRATIONS 1, 2 & 3.

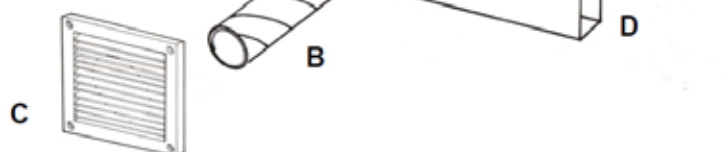

100MM  
VENT  
COVER



1000MM  
FLAT  
CHANNEL



CONNECTOR  
CHANNEL



100MM  
ROUND TO  
RECTANGLE  
ADAPTOR



VERTICAL  
90 DEGREE  
BEND



ELBOW BEND  
WITH 100MM  
SPIGOT



1000MM  
ROUND  
DUCT



# Installation Instructions

When installing these appliances, all local regulations, including those referring to national and European Standards need to be complied with.

This manual covers the appliances: Burley Models: 9103, 9104, 9105, 9108 and 9112

The nominal space heating output is:

**'Springdale' 9103: 3Kw**

**'Debdale' 9104: 4Kw**

**'Wakerley' 9112: 12Kw**

**'Hollywell' 9105: 5Kw**

**'Brampton' 9108: 8Kw**

Any of the above appliances should be installed by an installer registered with a competency scheme (i.e. HETAS/ELECSA England & Wales), conforming to Building Regulations Part J and the installation must be registered with the local council building control department.



**Failure to comply with the above renders all guarantees and liabilities of the manufacturer null and void.**

By carefully following the instructions below we are certain that you will enjoy many years of warmth and enjoyment from your new Burley Fireball Stove.

The manufacturer will not guarantee or accept liability for any problem that arises unless a local authority building control certificate has been completed and a valid receipt or proof of purchase is presented from the approved supplier.

The appliances should not be fitted closer to combustible materials, e.g. wooden fire surround or stud wall, than is shown in the table on page 5.

When fitted against a wall made of combustible material e.g. a wooden stud wall with plasterboard, unless a 75mm thick non-combustible material is used as a barrier, extra non-combustible material should be fitted behind the stove if the distance from the wall is less than shown. When fitted inside a masonry or similar non-flammable material recess, e.g., fireplace opening, there is no minimum distance; although we would advise a minimum of 50mm from any surface to allow for convection.

## The Clean Air Act 1993 and Smoke Control Areas

Under the Clean Air Act local authorities may declare the whole or part of the district of the authority to be a smoke control area. It is an offence to emit smoke from a chimney of a building, from a furnace or from any fixed boiler if located in a designated smoke control area. It is also an offence to acquire an "unauthorised fuel" for use within a smoke control area unless it is used in an "exempt" appliance ("exempted" from the controls which generally apply in the smoke control area).

The Secretary of State for Environment, Food and Rural Affairs has powers under the Act to authorise smokeless fuels or exempt appliances for use in smoke control areas in England. In Scotland and Wales this power rests with Ministers in the devolved administrations for those countries. Separate legislation, the Clean Air (Northern Ireland) Order 1981, applies in Northern Ireland. Therefore it is a requirement that fuels burnt or obtained for use in smoke control areas have been "authorised" in Regulations and that appliances used to burn solid fuel in those areas (other than "authorised" fuels) have been exempted by an Order made and signed by the Secretary of State or Minister in the devolved administrations.

Further information on the requirements of the Clean Air Act can be found here:

<https://www.gov.uk/smoke-control-area-rules>

Your local authority is responsible for implementing the Clean Air Act 1993 including designation and supervision of smoke control areas and you can contact them for details of Clean Air Act requirements

The 9103, 9104, 9105 and 9108 have been recommended as suitable for use in smoke control areas when burning wood logs.



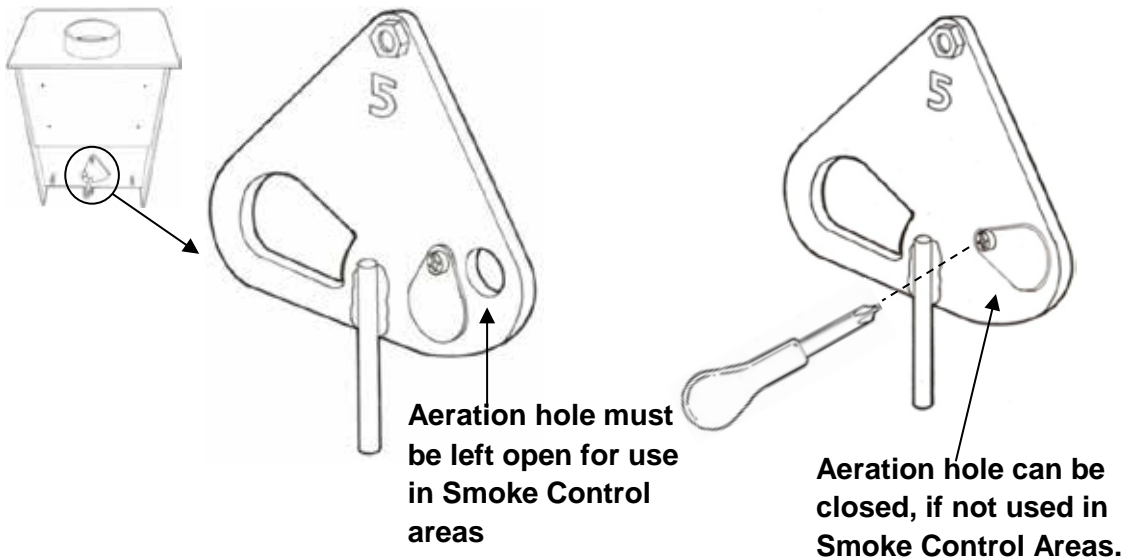

*This type of plate is only supplied with the 9103, 9104, 9105 & 9108 stoves which are approved for use in Smoke Control Areas. This type of plate is not supplied with the 9112 which is not approved.*

## Chimneys, Flues, Hearths and Surrounds

### Chimneys

The **9103 and 9104** require a minimum chimney flue of 5" (125mm), **9105, 9108 and 9112** models require a minimum chimney flue of 6" diameter (150mm). All chimneys/flues must be a minimum length of 4 metres and must comply with Building Regulations J. Never share the flue with another appliance.

If flue and chimney are not to these specifications there could be insufficient draw to pull oxygen through the appliance to make it burn properly. Due to the low temperature of the exiting flue gases we recommend that the flue is lined to the diameter specified in the table on page 5.

Larger flues over 200mm particularly ones containing voids may affect appliance performance. We specify particular size flues for efficient operation of our stoves.

If you live in a valley or are surrounded by tall trees or buildings you might experience downdraught problems where the wind tries to stop the fumes rising up the chimney. An anti-downdraught cowl might help, but anti-downdraught cowls reduce the draw.

We recommend you seek the advice of a HETAS (0845 634 5626) or NACE (01526 322 555) registered supplier and installer before purchasing any stove or heating appliance. It may be wise to contact your local chimney sweep before the stove is installed.

### Flue Pipe

We recommend 1mm stainless steel pipe sprayed matt black. Only use vitreous enamel pipe if it is stainless steel as mild steel can corrode over time.

### Hearths

The stove must stand on a non-combustible surface. Installation standards dictate that hearths must be at least 12mm thick, but installers must take into account the weight of the stove on such thin material.

The hearth should extend a minimum of 225mm in front of the stove. When a stove is freestanding the hearth should always extend a minimum of 150mm either side of the stove.



## **Strength and heat resistance of the hearth.**

Stoves are very heavy and most materials used for hearths crack very easily. It is impossible for Burley to inspect each hearth or comment on every installation, so the onus is on the installer to ensure the construction of the hearth is suitable for the application. Slate hearths can be particularly fragile. If in any doubt we recommend sliding a piece of vermiculite or calcium silicate insulation beneath the stove to protect it from the heat.

As guidance however:

- Do not use boxed and lipped hearths.
- Avoid marble, conglomerate or micro marble hearths.
- Rather than using one large piece of material, use sectional hearths or slabs which will move independently and allow for expansion due to heat. Should a slab section crack it is then easier and cheaper to replace.
- Bed hearths down on a level base, not directly on a hard surface which could be uneven.
- If necessary stand the stove on a steel or stone bed to ensure the weight is distributed.
- Do not subject the hearth to sudden impacts by dropping the stove. The stove is heavy and it is strongly recommended that lifting is undertaken by two people.
- Use the hearth protection squares provided in your Thank You Kit.

## **Surrounds**

 **Must be capable of withstanding the temperature produced by the stove and comply with the minimum distances to combustibles.**

## **Air Supply and Room Sealing Kit** *(Optional)*

All hydrocarbon burning appliances require an oxygen/air supply.

If the stove is to be fitted on an external wall the air supply can be taken straight from the outside by using the optional room sealing kit. A 100mm diameter hole needs to be drilled in the correct place (138mm above the hearth) to take the 86mm external (80mm internal) duct as supplied with the kit. This will allow for easy connection. Any gap can be filled in with cement or mastic.

- A proprietary grille is supplied with the kit.
- A room sealing kit which exits horizontally is available.

The room sealing method of supplying air is always to be preferred as heat loss from the room will be greatly reduced.

If the stove is not on an outside wall or the room sealing kit cannot be used, an air vent must be supplied in the room in which the stove is fitted. The sizes of the vents required are:

- 3Kw – No vent required
- 4Kw - No vent required
- 5Kw – For homes built before 2010 – no vent required. For homes built after 2010 - 550mm sq
- 8Kw - 1650mm sq (50mm diameter)
- 12Kw 4950mm Sq (100mm diameter)

Only permanently open vents can be used and consideration should be given to draught when the stove is not in use, therefore site this vent carefully. The vent covers should comply with Building Regulations Part J and should be sited where they cannot be blocked.

## **WARNING**

The Burley Fireball series of stoves are primarily for burning wood (this includes logs and sawdust briquettes). In smoke control areas only wood fuels should be used.

Before purchasing a stove we would strongly advise you seek the advice of a HETAS installer to ensure suitability of the product to your home.

Other fuels, such as coal (any type), smokeless fuels or petroleum coke can only be used if the optional multi-fuel grate is fitted (available on models 9104 and 9105 only). Under no circumstances should liquid fuels be added. It is not an incinerator and rubbish, including painted or tanned wood and MDF, should not be burnt in this appliance, doing so is potentially dangerous and will invalidate any guarantees immediately.

## **Stove Assembly**

### **Door Handle Adjustment**

There is a CAM and LOBE mechanism which allows the handle to be moved up and down or in and out. If required, adjust the handle so it lines up and engages correctly with the stud in the side of the stove. Incorrect alignment will put excessive force on the door hinges or will result in a poor seal between the door and the stove. The door may require adjustment as the rope seal compresses. A 5mm Allen key will be required.

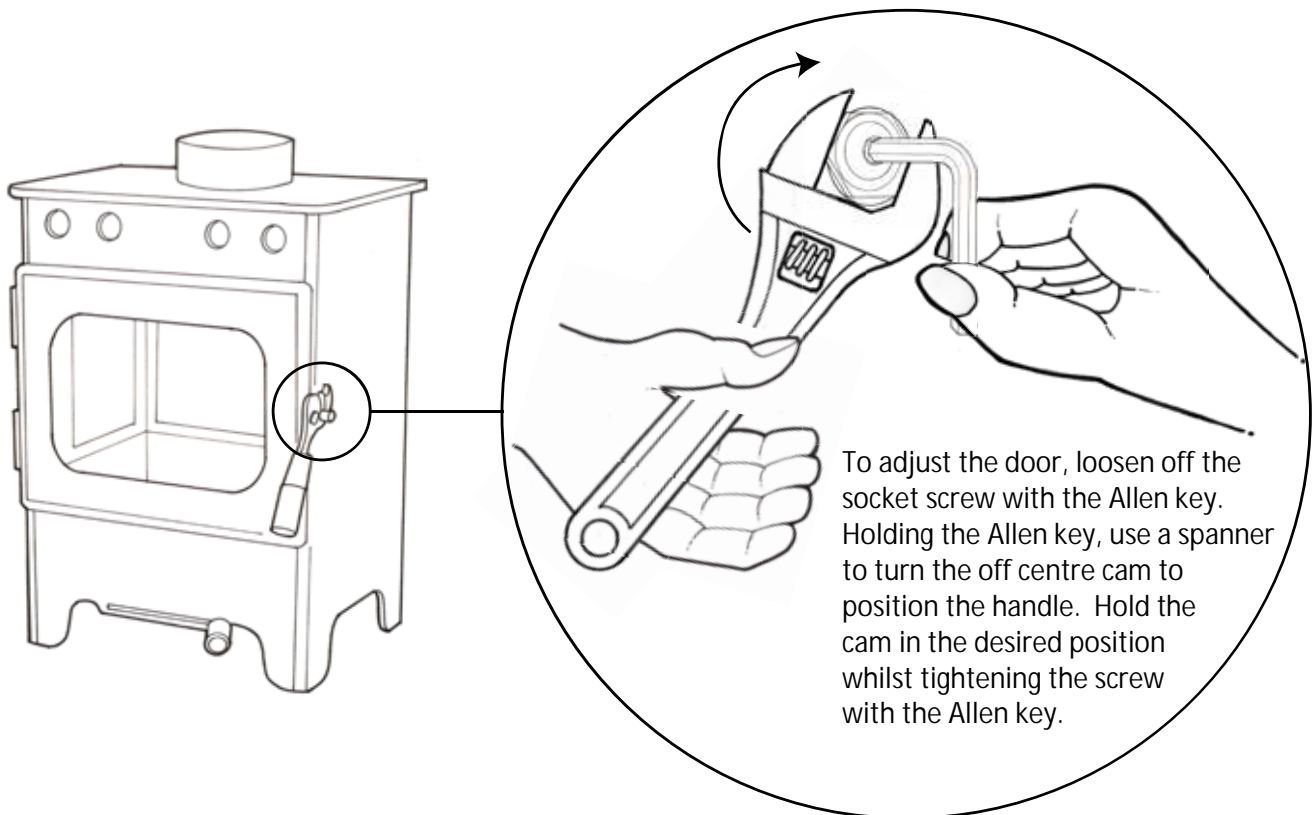

## Door Handle Assembly

The Door handle is pre-assembled and fitted to your stove. The information below is for reference only.

Fit the door handle and parts as per the assembly diagram below. (Please note it is very important to fit the parts in the correct sequence).

Tighten up the socket screw using the Allen key provided in the 'thank you' kit.

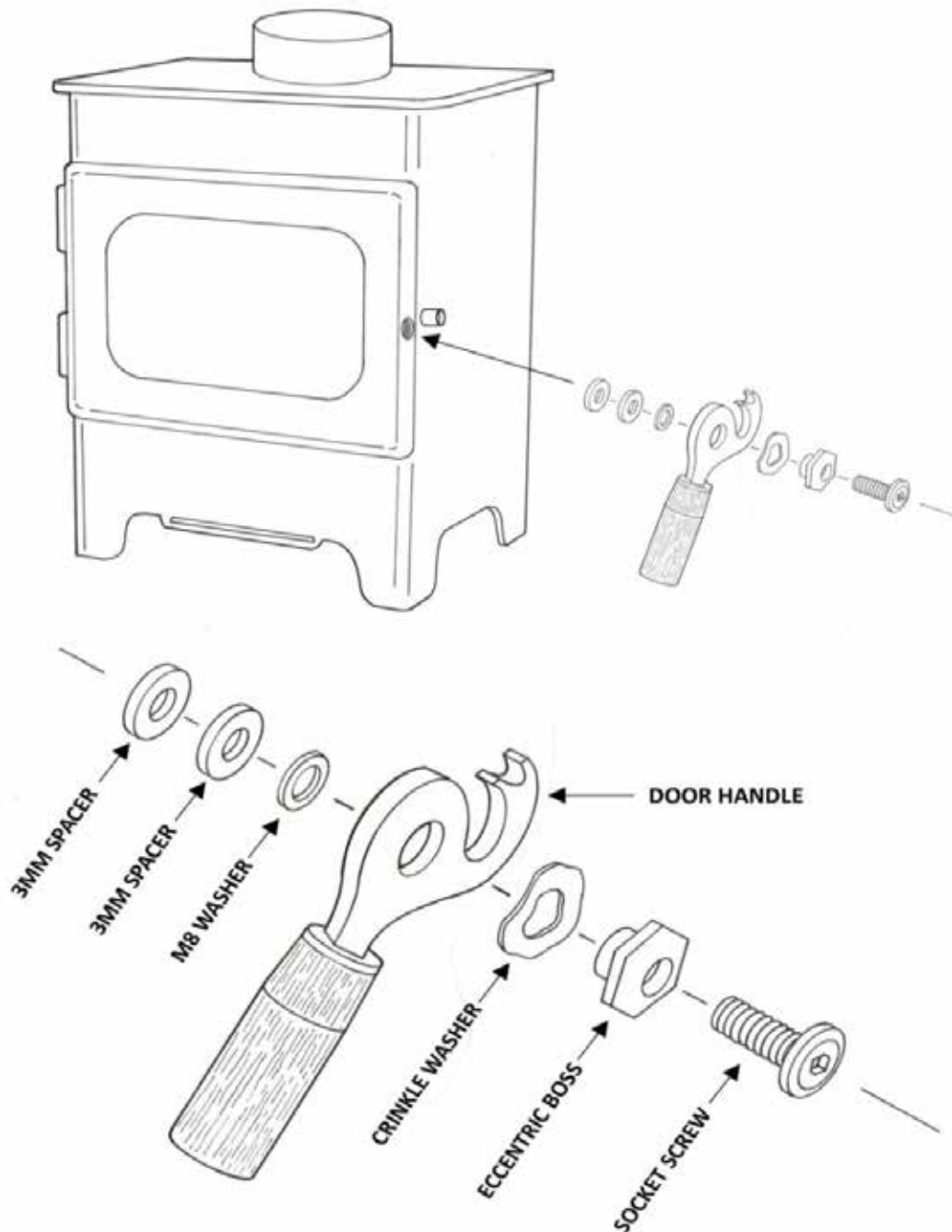

## Air Lever Assembly

Tilt the stove back on the rear legs and support it so you can access the underneath of the stove

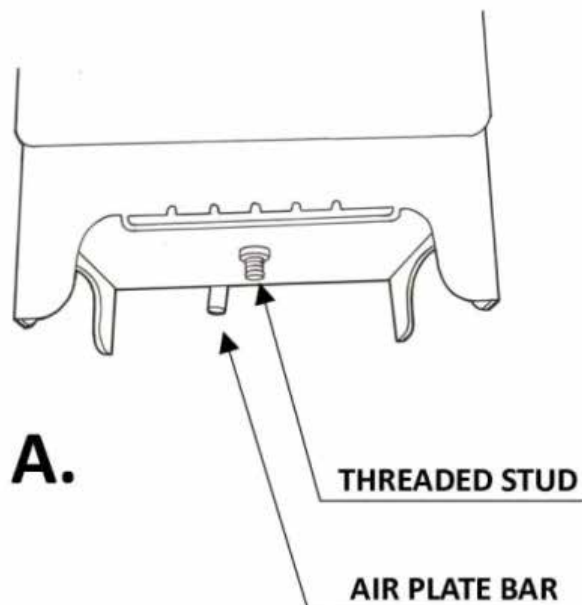

(A).

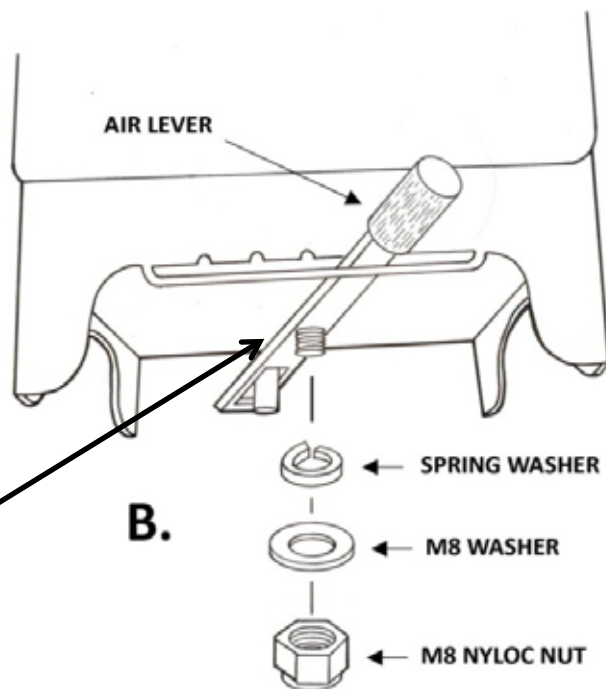

M10 Washer  
above lever arm

Put the M10 washer over the threaded stud, push the air lever through the slot in the front of the stove, locate the end of the lever over the air plate bar and threaded stud, ensuring that the M10 washer sits over the unthreaded shoulder of the stud. Assemble the remaining washers and nut as per diagram (B) using the 13mm spanner. Please ensure the lever moves from left to right with just a little resistance to ensure it stays in place.

### Levers and Handles

Please ensure that all levers and handles move correctly prior to positioning the stove in the opening or on the hearth. Adjustment may prove difficult once the stove is positioned.

Should the lever become loose over time adjustment can be made by tightening the nyloc nut at the rear or the one under the stove (as above). Do not apply excessive force to the M8 nyloc

## Optional Convection Tube Cover Plate

The cover plate is an option for those people who do not like the appearance of the convection tubes. *(This is not supplied with the Springdale 3kw stove)*

Fitting the cover plate is easy:

- (1) Offer the cover plate up to the stove and locate the clips on the rear into the tubes and push it on.
- (2.) Make sure it is fitted open at the top and flush at the bottom. This is important for the convection heat to come through the tubes.

Fitting the cover plate will not affect the efficiency of the stove.

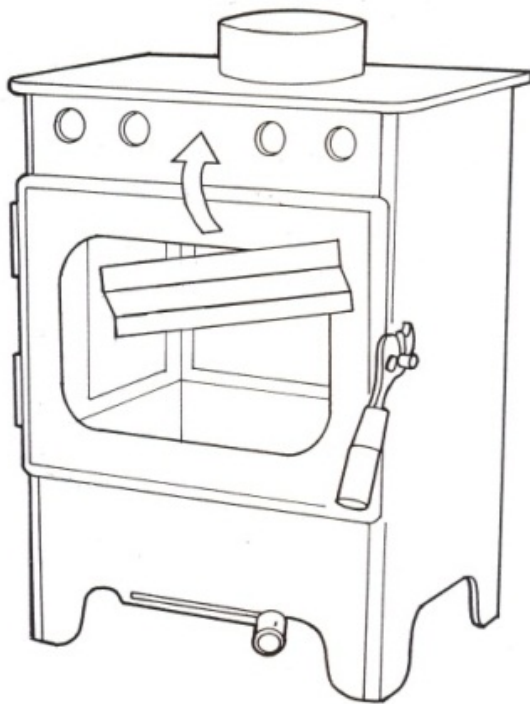

1

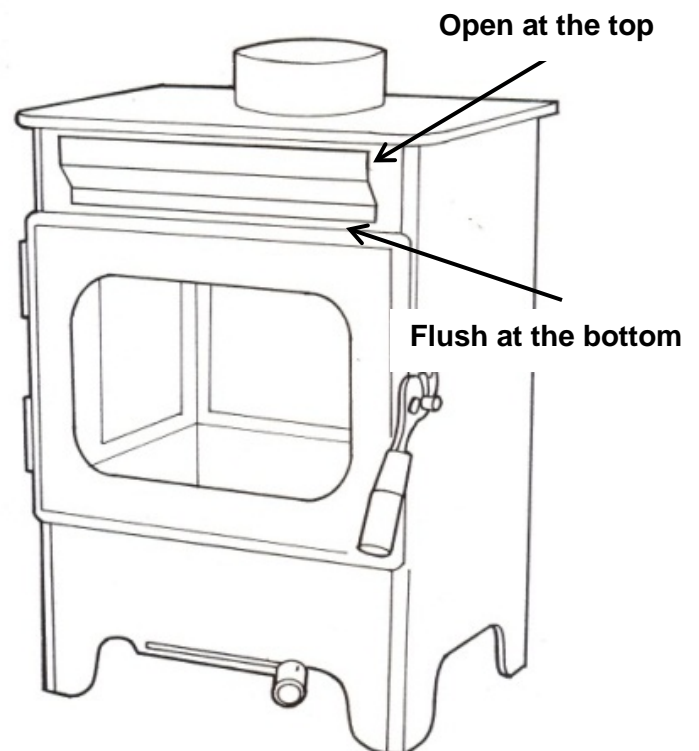

2

# Assembly and Installation of the Stove Fire Bricks and Baffle

Having positioned your Burley stove and connected it to a chimney with flue pipe, you need to assemble the inside parts.

There are five internal components: top brick, two side cheeks, a rear brick and a stainless steel baffle.

## Fitting of Stove Bricks

To fit the vermiculite bricks:

Place the left side in so the longer edge is at the front and the shorter edge at the rear.

Put the top brick in the stove so the rounded edges are at the back and the flat surface is up. The top brick should stay in place by resting it on the side brick and the top of the square metal tubes.

Place the right side in so the longer edge is at the front

Place the back in.

Slide the top brick backwards so the lip sits over the back and side bricks, keeping them in place and ensuring there is no gap at the back.

The base brick should already be fitted.



## Fitting the Stainless Steel Baffle Plate

Fit the plate by putting the legs of the plate on top of the rear square metal tubes, you may need to lift the top brick. Bring the plate forward so it sits on the ledge above the door. Check that the top brick is still at the back of the stove and has not moved forward.

When sweeping the chimney or carrying out regular maintenance on the stove, reverse the above procedure, clean the chimney and the top surface of the top baffle and the stainless steel mesh, then reposition all the components.

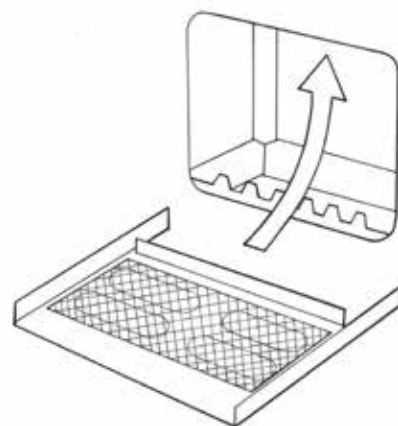

## Log Retaining Bar

Fit the log retaining bar so the angled return is pointing into the stove. This will help to keep the glass clean.

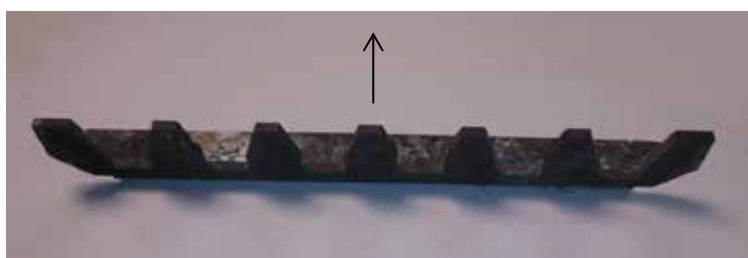

# Commissioning the Appliance

On completion of the installation, when any fire cement or paint used has dried, a smoke 'bomb' should be burnt and all joints checked for smoke leakage and the chimney draw checked with all doors and windows closed. Please leave the instructions with the customer and inform them;-

The first time the stove is lit only a small fire should be used to allow the paint to cure properly. **Ventilate the room well as the fumes can be pungent.** Use a small amount of kindling to start the fire. If possible leave the door on the catch, although the fire looks fierce it is comparatively cool due to all the air being drawn in. Add a little more kindling as it burns down. When you have a small bed of embers place a small split log in the fire, allow it to catch well, and then close the door with the lever to the right. Stay with the fire during this process. When this first log is burning down add another log, when this one is burning well you should be able to move the lever midway to the centre. Keep feeding the stove for three hours with a small split log as it burns low.

When you need to remove some ash wait until it is cold and then take some out using the scoop provided. Always leave an inch of ash so you have a nice bed for your next fire.

## USER INSTRUCTIONS

### To Light the Stove

It is important to keep an approximate minimum depth of  $\frac{3}{4}$ " (20mm) of wood ash in the fire box at any time. You will achieve this after the first few firings.

Place 1 or 2 firelighters in the bottom, then add some kindling wood criss-crossed, and finally a small log on top. Light the firelighters open the air vent to maximum (to the right) and close the door to the first latch so there is an air gap around it.

Leave it like this for around five minutes or so, the fire should be well alight and the door can now be closed to become air tight. Leave the air control lever to the right for a further 10 to 20 minutes to get the stove completely up to running temperature. If the stove does go out when the door is closed then the flue is still too cold and will not pull, in this case you may need to leave the door open with kindling burning for longer. The flue's pull will change dependant on temperature and atmospheric conditions.

The best lever position to achieve maximum efficiency will depend on the chimney draw, but will normally be near the centre. Every chimney is different, and you will eventually find your stove's optimum position. This is when the flames are swirling in a lazy manner around the stove, not roaring. If the lever is pushed too far to the left, you starve the fire of oxygen, causing the glass to darken. Move the lever a small amount to the right until the glass just stays clean. We do not recommend use of a stove thermometer – the high efficiency of the stove means flue gases are cool and would give an inaccurate reading, leading to over firing and damage to internal components.

The best way to run any wood stove is 'little and often'. If you are with the fire, it is best to keep adding a small log every 45 minutes rather than adding large ones every 2 hours.



**THE STOVE IS NOT DESIGNED TO BE USED WITH THE DOOR OPEN!**

To reload, open the door slowly to allow the pressure to equalise. Using the glove provided, place the fresh log towards the rear of the appliance. Close the door.

**Do not over load the stove with wood and close the damper down, this produces lots of creosote and blackens the glass**



## Recommended fuels & using the Moisture Meter

Model	9103	9104	9105	9108	9112
Requirement of fuels used in Smoke Control Areas	Dry logs <20% H <sub>2</sub> O	Dry logs <20% H <sub>2</sub> O	Dry logs <20% H <sub>2</sub> O	Dry logs <20% H <sub>2</sub> O	<b>Not for Use in Smoke Control Areas</b>
	Maximum length 170 -220mm long	Maximum length 200 -250mm long	Maximum length 250 -300mm long	Maximum length 250 -350mm long	
	Maximum width 150mm	Maximum width 150mm	Maximum width 150mm	Maximum width 150mm	

For the stove to operate at maximum efficiency the wood should be as dry as possible, certainly below 18%. Burning damp or wet wood will not only stop the stove working efficiently, but also create excess smoke and stain the glass.

Remove the plastic cap covering the two contact pins. The pins are sharp for a reason, so please use it carefully. Push the pins into the **inner surface** of the split log (5mm as a guide) this will give an accurate reading.

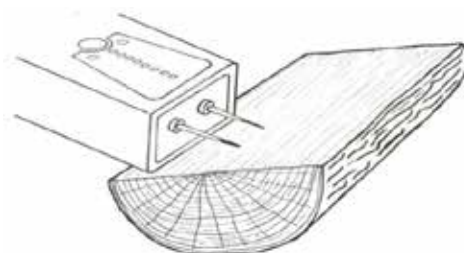

Simply putting the contact pins onto the surface will not give an accurate reading, as it may tell you that the surface is dry whilst the interior of the log may well be damp.

### **Stove Thermometers - DO NOT USE WITH OUR STOVES**

We receive a very small number of calls from customers who have managed to damage their stoves from over-firing, in almost all cases they have a thermometer fitted to their flue.



The Fireballs are the world's most efficient stove because firstly, due to the unique method of introducing air, the combustion chamber is extremely hot, and secondly, the heat is extracted from the combusted gasses to heat the room before it enters the flue.





On the Hollywell for example, the gasses have been cooled to just 122 °C, far below what the stove thermometer will measure. Because the thermometer is not 'in the green', you think that the stove is not operating efficiently, so load the chamber with wood and have the air wide open.

This creates such an inferno that occasionally the ceramic glass can frost (something even the windows on the space shuttle could not achieve during re-entry), and although it is very rare, the stainless steel baffle can also be damaged, stainless steel melts at over 1500°C!

The ONLY thing that a stove thermometer shows is that you have an inefficient stove and are losing a lot of heat up the flue, not a great deal of use really.

## Troubleshooting/Poor Appliance Operation

	<b>Refuelling onto a low fire bed</b>	If there is insufficient burning material in the fire bed to light a new fuel charge, excessive smoke emission can occur. Refuelling must be carried out onto a sufficient quantity of glowing embers and ash to ensure that the new fuel charge will ignite. If the fuel bed is too low or cool, suitable kindling must be used to re-light fires.
	<b>Air damper left fully open</b>	Although the fire will look impressive, you will be burning more wood for less heat. The glass can also be damaged.

	<b>Leaving door open</b>	Operation with the door open can cause excess smoke and a potential fire hazard. The appliance must not be operated with the door left open except as directed in the instructions.
	<b>Overloading the fire bed</b>	The maximum amount of fuel specified in this manual should not be exceeded. The weight of dry wood per hour is: 1.0kg for the 9103, 1.3kg for the 9104, 1.6kg for the 9105, 2.8kg for the 9108 and 4.4kg for the 9112. Overloading can damage components of the stove. <b>The stove is not designed for overnight operation.</b>
	<b>Substantial Smoke Emission</b>	If substantial smoke emission is observed from the appliance at any time during the operation of the appliance the operator should ensure they are following the operation instructions and using <u>suitable</u> fuel. The flue may not be pulling as it is too cold or incorrectly specified/installed. There might be a down draught. Check that the top brick is at the back of the fire.
	<b>Door Adjustment</b>	The locking mechanism on the door is made up of a cam and lobe assembly. The door can be loosened or tightened with an Allen key (see page 10). The door will need to be adjusted over time as the rope seal compresses.

## Reasons for Premature Wear of Internal Parts





- Stove being used/fired too vigorously
- Too little air passing through the stove
- Use of excessively dry wood (wood from old furniture, carpentry offcuts)
- Excessive debris collection on baffle plate or inner fireback (see section on cleaning)
- Ash level too high in the ash pan over 2 ½ “
- Overnight burning
- Use of a stove thermometer (see page 16)

## Care of Glass

The first few firings will cure the paint and we recommend that you clean the glass after this has happened. This will ensure that there are no contaminants on the glass to attract further staining. After a time the glass does deteriorate but to prolong the life:

- Clean the glass each time before re-lighting, this prevents fly-ash from being fired onto the glass
- Clean glass with a ceramic glass cleaner
- If necessary, remove fired on stains with clean wire wool (not a ‘brillo’ type pad) every time before lighting
- Ensure all glass cleaner is removed from glass before firing
- Do not over aerate the stove as this can cause fly ash to stick.
- Do not run for long periods with the lever to the right
- Only add logs at the back of the stove
- Make sure the log retainer points into the stove
- Most deposits burn off when the stove is very hot, this is with the lever roughly in the middle
- Do not over load the stove or try and keep it in overnight. Add a little wood often.

The stove is double glazed; check the rope seals and screws regularly to ensure a long life.

-  **Take care when removing glass clip screws or they could shear**
-  **Do not use with broken glass**
-  **Do not over tighten the glass clips as this could cause the internal glass to crack.**
-  **Only clean the glass when it is cold and clean daily to prevent build-up of deposits.**

## Chimney Sweeping and Maintenance

It may be wise to contact your local chimney sweep before the stove is installed. Your chimney should be swept at least once a year by a registered sweep, twice a year with heavy use. The sweep should also replace the fire cement at the base of the flue if necessary.

- The chimney can be swept through the stove.
- The stainless steel baffle and top brick should be removed in the reverse order described on page 14.
- The baffle should be cleaned at least twice a year with heavy use, checked, renewed as required and replaced.
- Unless advised by Burley the stove should not be used with any baffle missing.
- All rope and glass seals should be checked annually and replaced as necessary.

If the stove has not been used for a prolonged period, in excess of 6 months, the chimney should be swept prior to use to check for blockages, birds' nests etc. and rubble/debris blocking the flue ways.

## Safety



**NOTE:** As with all solid fuel appliances, a carbon monoxide detector should be purchased for use in the room. All solid fuel appliances produce considerably more Carbon Monoxide in normal use than oil or gas appliances, but the general 'smell' of the smoke or exhaust is much stronger and more easily detected by a healthy person.

- Always use your appliance with the door shut and look for tell-tale signs of excessive leakage: smoke stains above the fireplace, smoke emitting around the door when running, strong smell of soot upstairs etc.
- Check the seals at the joints annually and replace the fire cement as required. Check especially the joint of the flue pipe to the chimney register plate, hairline cracks are OK, but lumps of cement missing produce a bad joint. A proprietary jointing compound should be used here, as it is far superior to a cement and rope seal.
- Never block air vents either internally or externally.
- Use the supplied glove to reload the stove.
- In the event of a chimney fire, close the door and shut the air vent right down. If possible throw ½ cup of coarse table salt onto the fire.
- Never modify parts or fit parts to the appliance that are not recommended by the manufacturer.
- Never use this appliance in the same flue as another appliance.

- The surface of a wood burning stove gets extremely hot in normal use. When using the stove in situations where children or aged and/or infirm persons are present, a fireguard must be used to prevent accidental contact with the stove. The fireguard should be manufactured in accordance with BS 8423:2002.

## Warranty

All our stoves are covered by a five year metalwork warranty. **(This is subject to the correct fuel having been used and not overloading or over aerating the stove.)**

The five year warranty covers the stove body only and does not include consumable items such as grates, firebricks, vermiculite panels, baffles, log guards, door rope and glass.

**Any warranty claims should be addressed to your original supplier and accompanied with the date of purchase and serial number of the appliance.**

## If you need further help...

**If you need further help with your Burley Stove then the first point of contact should be your HETAS installer, who will be able to provide the answers to most questions.**

Your Burley retailer also has a great deal of experience and will also be able to provide helpful advice. Further help is available from Burley's Customer Services department who will be pleased to give advice, if necessary.

## Spare Parts

If you need to replace the consumable items in your Burley stove then please contact your retailer who will be able to source the parts for you.

Common parts that "wear out":

DESCRIPTION	9103		9104		9105		9108		9112	
	PART NO	QTY	PART NO	QTY	PART NO	QTY	PART NO	QTY	PART NO	QTY
TOP VERMICULITE BOARD	WTOPLINER3	1	WTOPBAFFLE4	1	WTOPBAFFLE5	1	WTOPBAFFLE8	1	WTOPBAFFLE12	1
BACK VERMICULITE BOARD	WBACLINER3	1	WBACLINER4	1	WBACLINER5	1	WBACLINER8	1	WBACLINER12	1
BOTTOM VERMICULITE BOARD	WBOTLINER3	1	WBOTLINER4	1	WBOTLINER5	1	WBOTLINER8	1	WBOTLINER12	1
LEFT HAND VERMICULITE BOARD	WL/HLINER3	1	WL/HLINER4	1	WL/HLINER5	1	WL/HLINER8	1	WL/HLINER12	1
RIGHT HAND VERMICULITE BOARD	WR/HLINER3	1	WR/HLINER4	1	WR/HLINER5	1	WR/HLINER8	1	WR/HLINER12	1
GLASS	WGLASS/3	2	WGLASS/MIC	2	WGLASS/S	2	WGLASSM	2	WGLASSL	2
GLASS CLIPS	WGLASSCLIP/M	2	WGLASSCLIP/M	2	WGLASSCLIP/S	2	WGLASSCLIP/S	2	WGLASSCLIP/L	2
GLASS ROPE TAPE	WROPE	1M	WROPE	1M	WROPE	1M	WROPE	2M	WROPE	3M
DOOR SEAL ROPE (20mm)	WSEALROPE	1.1M	WSEALROPE	1.3M	WSEALROPE	1.5M	WSEALROPE	1.8M	WSEALROPE	2.4M
STAINLESS STEEL BAFFLE	WLOWBAF9103	1	WLOWBAFMIC	1	WLOWBAFSMA	1	WLOWBAFMED	1	WLOWBAFLAR	1

# Customer & Installation Notes

Date of Installation:	
-----------------------	--

Installer Name & contact details

Chimney Swept By:	Date

Notes:



Made in the UK



**Burley Appliances Limited**  
Lands' End Way  
Oakham  
Rutland  
LE15 6RB  
United Kingdom

Further information can be found at:  
[burley.co.uk/woodburner.php](http://burley.co.uk/woodburner.php)

Email: [sales@burley.co.uk](mailto:sales@burley.co.uk)  
Phone: 01572 756956  
Fax: 01572 724390